

NHS150-48 : Ultra-High efficient DC/DC converters

Features

- Industry standard Half-Brick pin map
- High efficiency
- Wide operating temperature range
With derating (-40°C to +85°C)
- Precision thermal protection(Accuracy $\pm 3^{\circ}\text{C}$)
- Over current protection
- Under voltage lockout (UVLO)
- Output over voltage protection
- Remote on/off control
- Output voltage variation (TRM)
- Positive/Negative remote sense
- RoHS directive



Applications

- Telecommunication/Network equipment
- High current microprocessors and ICs
- Instrumentation / Equipments
- Distributed Power Systems

Description

NHS150-48 series are isolated dc/dc converter that is designed to be ultra-high efficient, precision thermal protection.

Features include high isolation, output over-voltage protection, over current limiting, short-circuit protection, thermal shutdown, remote on/off control, output trim and (\pm)output sense functions.

NHS150-48 Series: Isolated DC/DC Converters
36 – 75V Input, Maximum Power : 150WData Sheet
Mar. 3, 2008**Absolute Maximum Ratings**

Parameter	Min.	Typ.	Max.	Unit	Notes
Input voltage continuous	36	-	75	Vdc	
Operating ambient temperature	-40	-	85	°C	
Storage temperature	-40	-	105	°C	
I/O isolation voltage	-	1500	-	VDC	

Stresses in excess of the absolute maximum ratings can cause permanent damage to the device.

Electrical Specifications

Ta=25°C, Airflow rate=400LFM, Vin=48Vdc unless otherwise noted.

Input Characteristics

Parameter	Symbol	Min.	Typ.	Max.	Unit
Operating voltage range		36	48	75	Vdc
Input under voltage lockout		34.0	-	35.9	Vdc
Disabled input current (Remote on/off control)		-	6.2	-	mA
Maximum Input current (At minimum input voltage and maximum output power)					
NHS150-48-3R3	I_{in}	-	3.0	-	A
NHS150-48-5		-	4.5	-	A
NHS150-48-12		-	4.53	-	A
No load input current					
NHS150-48-3R3		-	50	-	mA
NHS150-48-5		-	90	-	mA
NHS150-48-12		-	63	-	mA
Input reflected ripple current (Maximum output power)					
NHS150-48-3R3		-	180	-	mA
NHS150-48-5		-	254	-	mA
NHS150-48-12		-	332	-	mA

NHS150-48 Series: Isolated DC/DC Converters
 36 – 75V Input, Maximum Power : 150W

 Data Sheet
 Mar. 3, 2008

Output Characteristics

Parameter	Symbol	Min	Typ	Max	Unit
Output voltage tolerance	V_o	-	-	2	%
Output regulation;					
- Line regulation		-	± 0.2	± 0.5	%
- Load regulation		-	± 0.2	± 0.5	%
Output current	I_o				
NHS150-48-3R3		0	-	30	A
NHS150-48-5		0	-	30	A
NHS150-48-12		0	-	12.5	A
Output current limit(Automatic recovery)		105	-	-	%
Output ripple and noise, ($V_{in} = 48V$, $I_o = \text{Max. output current}$, $1\mu F$ ceramic + $15\mu F$ tantalum, Bandwidth : 20MHz, See fig.30)					
NHS150-48-3R3		-	-	75	mV
NHS150-48-5		-	-	75	mV
NHS150-48-12		-	-	120	mV
Efficiency ($V_{in} = 48V$, 100% Load)					
NHS150-48-3R3		-	90.31	-	%
NHS150-48-5		-	91.05	-	%
NHS150-48-12		-	92.60	-	%
Dynamic load response ($1\mu F$ ceramic + $15\mu F$ tantalum, 50% to 75 %, 75% to 50%, Slew rate = $0.1A/\mu s$, See fig.30)					
NHS150-48-3R3		-	± 180	-	mV
NHS150-48-5		-	± 180	-	mV
NHS150-48-12		-	± 230	-	mV
Recovery time(with in 1% Nominal V_o)					
NHS150-48-3R3		-	200	-	μs
NHS150-48-5		-	100	-	μs
NHS150-48-12		-	300	-	μs
Start-up time		-	2	4	ms

NHS150-48 Series: Isolated DC/DC Converters
 36 – 75V Input, Maximum Power : 150W

 Data Sheet
 Mar. 3, 2008

Turn-on overshoot		-	0	-	%
Maximum output capacitance					
NHS150-48-3R3		-	1470	-	μF
NHS150-48-5		-	2200	-	μF
NHS150-48-12		-	2200	-	μF

Isolation Specifications

Parameter	Symbol	Min	Typ	Max	Unit
I/O isolation voltage					
- Input-output:		-	1500	-	Vdc
- Input-case:		-	1000	-	Vdc
- Output-case:		-	1000	-	Vdc
I/O isolation resistance	RISO	-	100	-	M Ω
Isolation capacitance	CISO	-	2.2	-	nF

General Specifications

Parameter	Symbol	Min	Typ	Max	Unit
Switching Frequency		320	350	380	KHz
Remote ON/OFF (Positive Logic)					
On = open		2.5	-	7	Vdc
Off = short to Vin-		0	-	0.8	Vdc
Output voltage trim range		-	-	± 10	%
Output voltage remote sense range		-	-	10	%
Over-temperature shutdown		-	100	-	$^{\circ}\text{C}$
Over-temperature accuracy		-	± 3	± 3	$^{\circ}\text{C}$
Over temperature restart hysteresis		-	-	11	$^{\circ}\text{C}$
MTBF(Io=80%, Ta=25 $^{\circ}\text{C}$, Air flow=400LFM)		179200			hrs
Dimensions(W.H.L.)		58.4 x 61 x 12.7 (2.28 x 2.4 x 0.5)			mm (inches)
Weight		-	180	-	g

NHS150-48 Series: Isolated DC/DC Converters
36 – 75V Input, Maximum Power : 150WData Sheet
Mar. 3, 2008**Environmental**

Parameter	Symbol	Min	Typ	Max	Unit
Operating Temperature		-40	-	85	°C
Storage Temperature		-40	-	105	°C

NHS150-48 Series: Isolated DC/DC Converters
36 – 75V Input, Maximum Power : 150WData Sheet
Mar. 3, 2008**Characteristic Curves**

The following fig.1~9 provide typical characteristics for NHS150-48-3R3 (3.3V/30A).

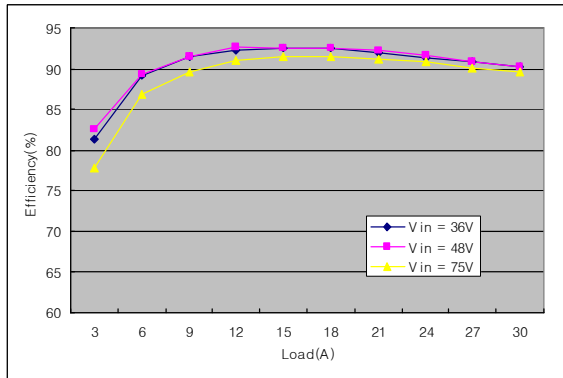
Efficiency

[Fig.1] Efficiency for 36V, 48V and 75V input Voltage at 25°C, 400LFM.

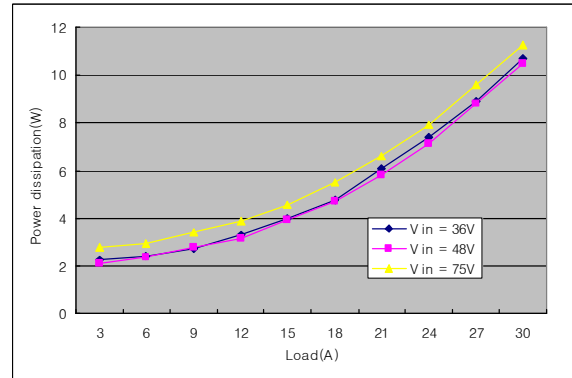
Power Dissipation

[Fig.2] Power dissipation for 36V, 48V and 75V input voltage at 25°C, 400LFM.

NHS150-48 Series: Isolated DC/DC Converters
 36 – 75V Input, Maximum Power : 150W

Data Sheet
 Mar. 3, 2008

Output Load Transient Response

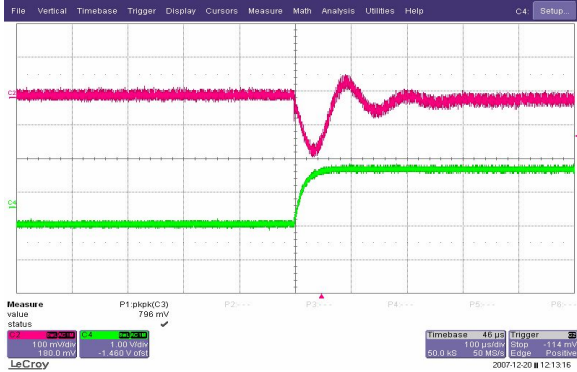

[Fig.4] Load step: 50%-75% of I_o , $di/dt=$ 0.1A/us (CH1: 100mV, CH2: 5A/div, 100us/div)

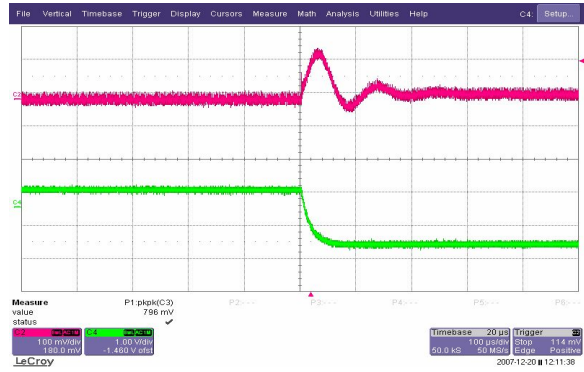

[Fig.5] Load step: 70%-50% of I_o , $di/dt=$ 0.1A/us (CH1: 100mV, CH2: 5A/div, 100us/div)

Output Ripple/Noise

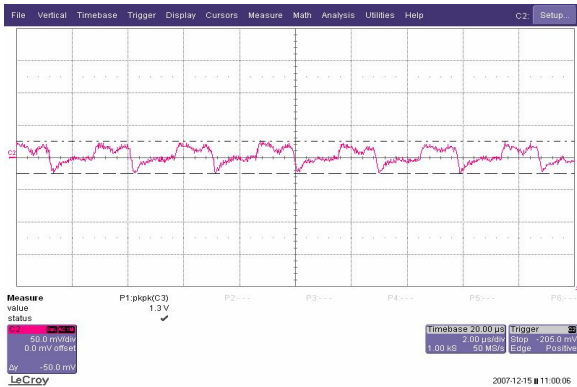

[Fig.6] Output ripple & noise (50mV/div)
 (1μ F ceramic + 15μ F tantalum,
 Bandwidth : 20MHz, See fig.30)

Start-up from On/off input

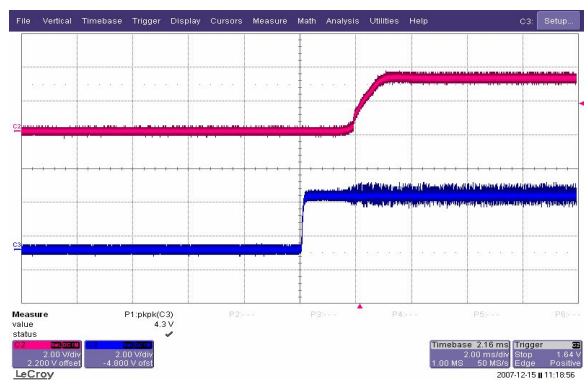

[Fig.7] Ch2: V_o , Ch3: On/off input (2ms/div)

Input Reflected Ripple Current

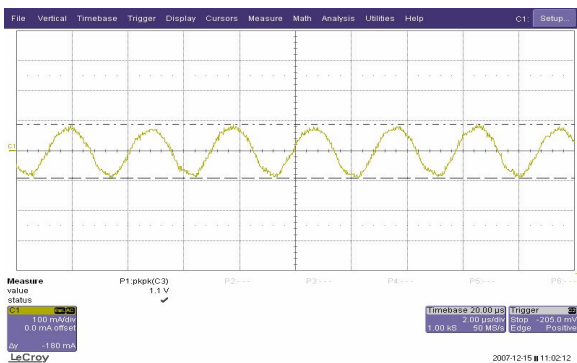

[Fig.8] Input reflect ripple current (100mA/div)

Output Impedance

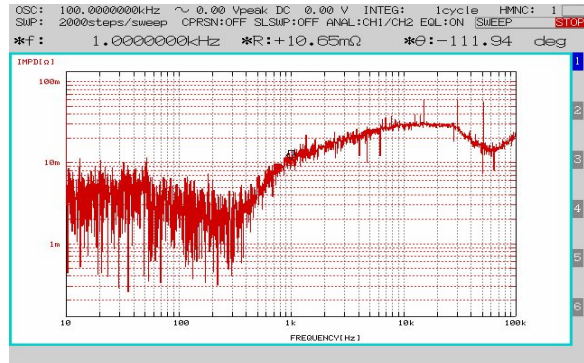

[Fig.9] Output impedance at 100% Load

NHS150-48 Series: Isolated DC/DC Converters
36 – 75V Input, Maximum Power : 150WData Sheet
Mar. 3, 2008**Characteristic Curves**

The following fig.10~18 provide typical characteristics for NHS150-48-5 (5V/30A).

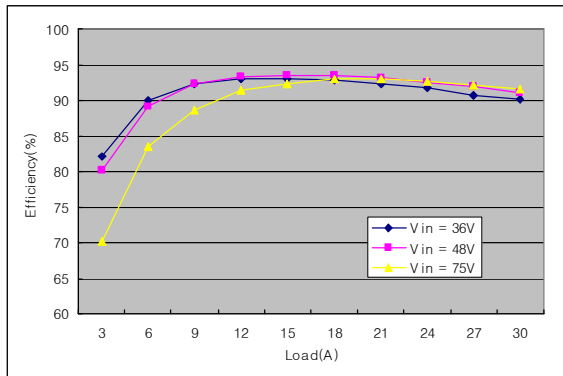
Efficiency

[Fig.10] Efficiency for 36V, 48V and 75V input Voltage at 25°C, 400LFM.

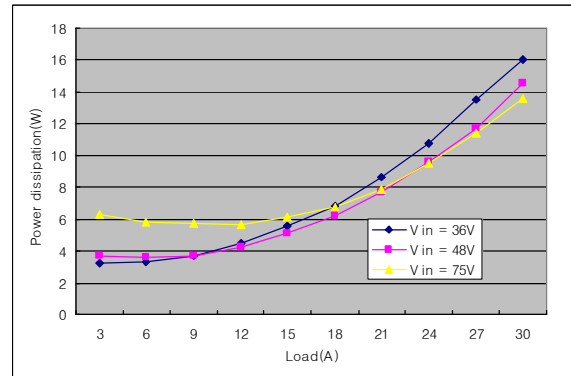
Power Dissipation

[Fig.11] Power dissipation for 36V, 48V and 75V input voltage at 25°C, 400LFM.

NHS150-48 Series: Isolated DC/DC Converters
36 – 75V Input, Maximum Power : 150W

Data Sheet
 Mar. 3, 2008

Output Load Transient Response

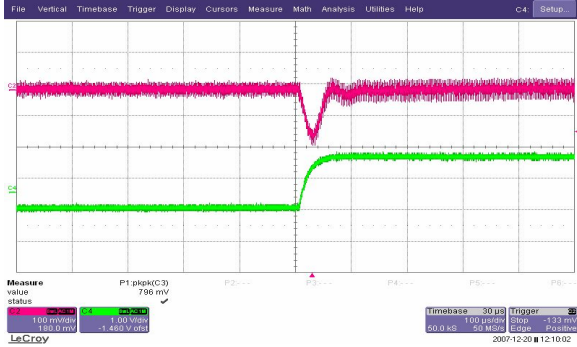

[Fig. 13] Load step: 50%-75% of I_o , $di/dt=0.1A/us$ (CH1: 100mV, CH2: 5A/div, 100us/div)

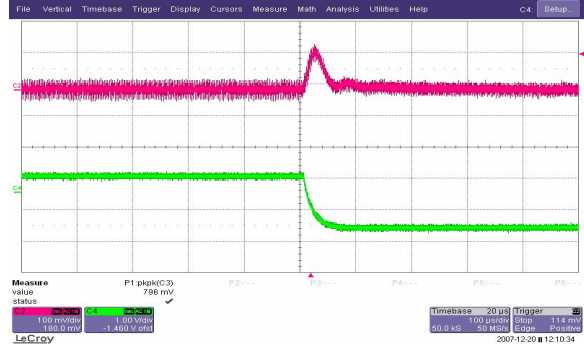

[Fig. 14] Load step: 70%-50% of I_o , $di/dt=0.1A/us$ (CH1: 100mV, CH2: 5A/div, 100us/div)

Output Ripple/Noise

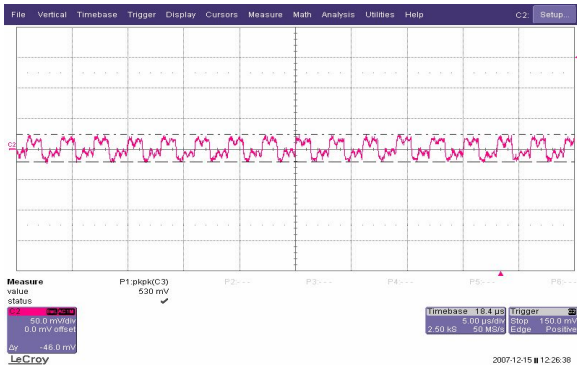

[Fig. 15] Output ripple & noise (50mV/div)
 ($1\mu F$ ceramic + $15\mu F$ tantalum,
 Bandwidth : 20MHz, See fig.30)

Start-up from On/off input

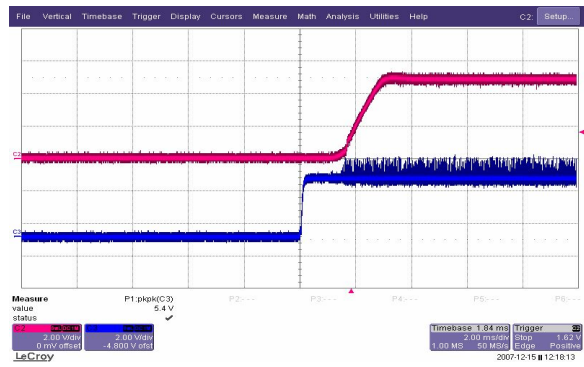

[Fig. 16] Ch2: V_o , Ch3: On/off input(2ms/div)

Input Reflected Ripple Current

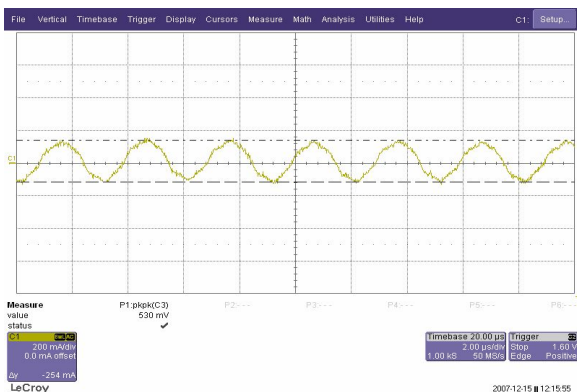

[Fig. 17] Input reflect ripple current (200mA/div)

Output Impedance

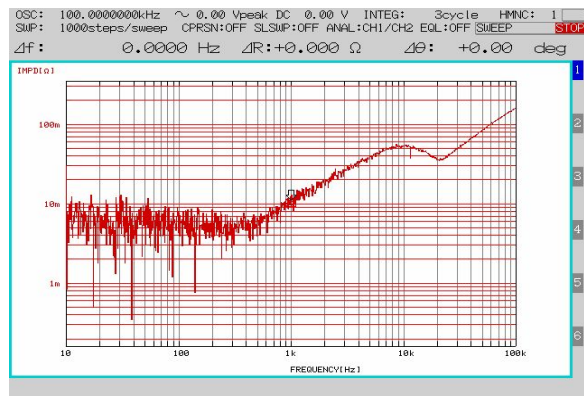

[Fig. 18] Output impedance at 100% Load

NHS150-48 Series: Isolated DC/DC Converters
36 – 75V Input, Maximum Power : 150WData Sheet
Mar. 3, 2008**Characteristic Curves**

The following fig.19~27 provide typical characteristics for NHS150-48-12 (12V/12.5A).

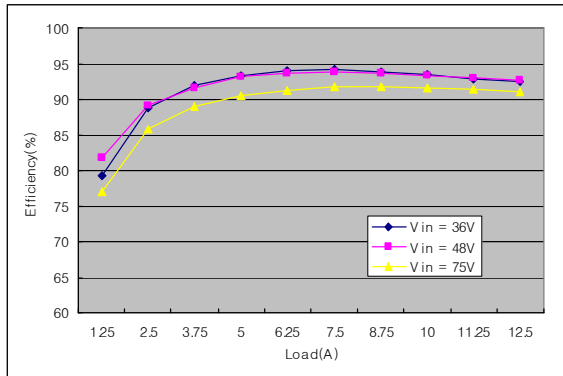
Efficiency

[Fig.19] Efficiency for 36V, 48V and 75V input Voltage at 25°C, 400LFM.

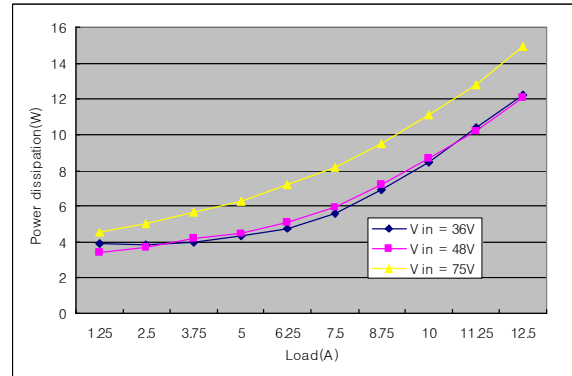
Power Dissipation

[Fig.20] Power dissipation for 36V, 48V and 75V input voltage at 25°C, 400LFM.

NHS150-48 Series: Isolated DC/DC Converters
 36 – 75V Input, Maximum Power : 150W

Data Sheet
 Mar. 3, 2008

Output Load Transient Response

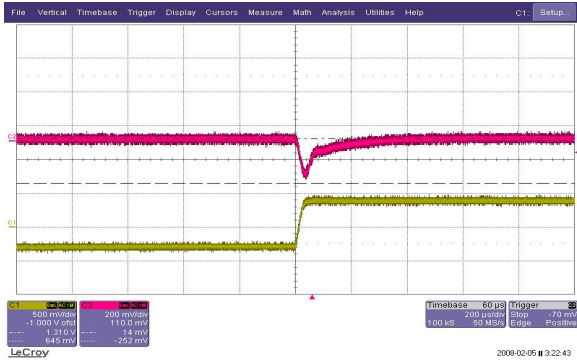

[Fig.22] Load step: 50%-75% of I_o , $di/dt=0.1A/\mu s$ (CH1: 200mV, CH2: 2.5A/div, 200us/div)

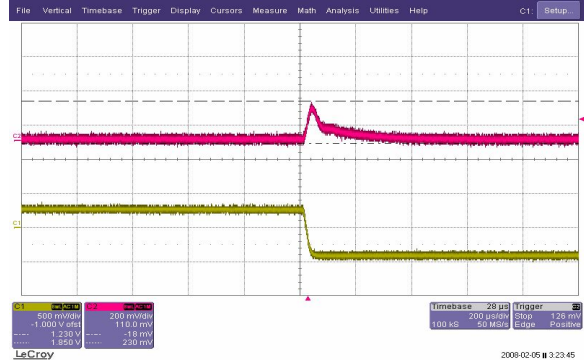

[Fig.23] Load step: 70%-50% of I_o , $di/dt=0.1A/\mu s$ (CH1: 200mV, CH2: 2.5A/div, 200us/div)

Output Ripple/Noise

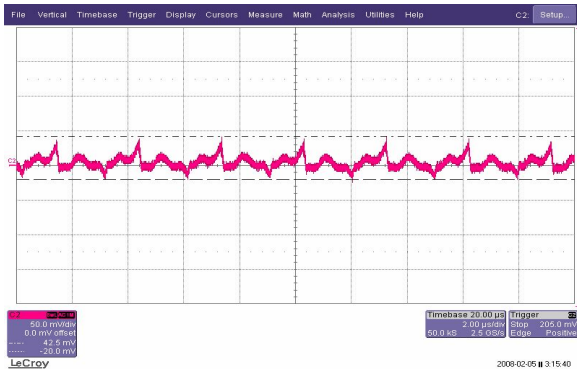

[Fig.24] Output ripple & noise (50mV/div)
 ($1\mu F$ ceramic + $15\mu F$ tantalum,
 Bandwidth : 20MHz, See fig.30)

Start-up from On/off input

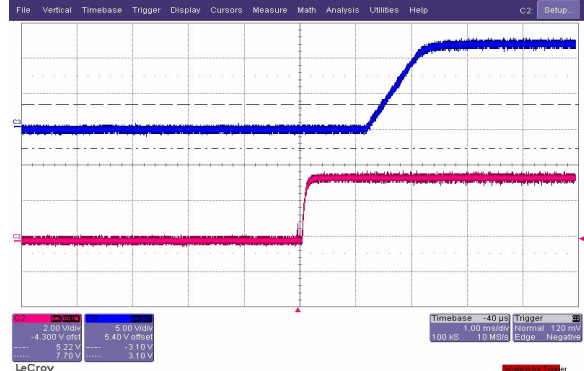

[Fig.25] Ch2: V_o , Ch3: On/off input(2ms/div)

Input Reflected Ripple Current

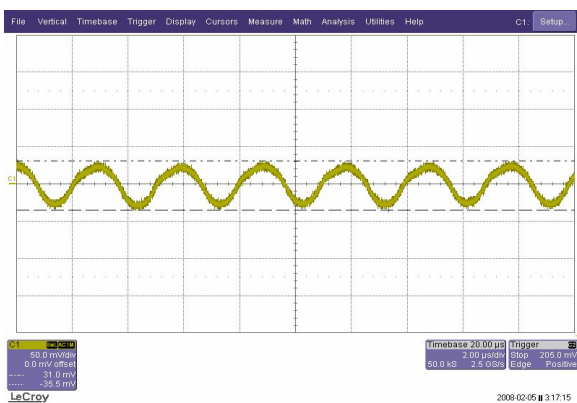

[Fig.26] Input reflect ripple current (250mA/div)

Output Impedance

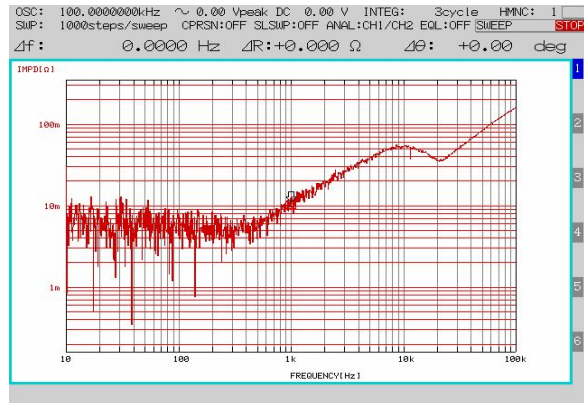

[Fig.27] Output impedance at 100% Load

TEST Configurations

Output Voltage and Efficiency

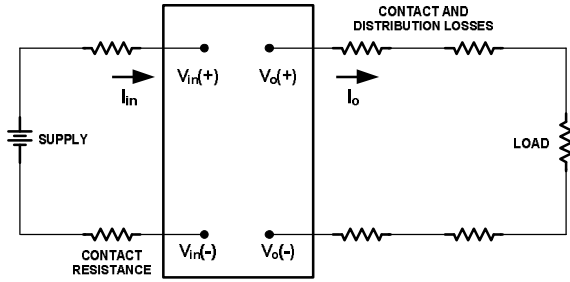

[Fig.28]

*All measurements are taken at the module terminals when socketing, place Kelvin connections at module terminals to Avoid measurement errors due to socket contact resistance.

Efficiency

$$\eta = \left(\frac{[V_o (+) - V_o (-)] \times I_o}{[V_{in} (+) - V_{in} (-)] \times I_{in}} \right) \times 100\%$$

Thermal Considerations

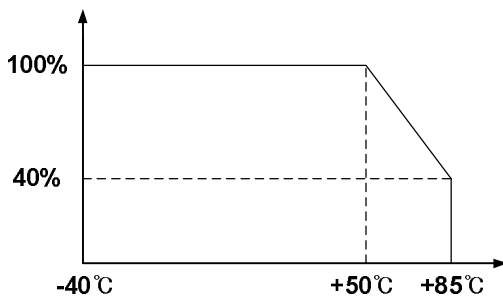

[Fig.29]

This products has wide operating temperature range from -40°C to +85°C.

However, it should be required a enough air flow for more reliable operation. Output derating curve provide designers with a quantity of a current under the desired ambient temperature and velocity of airflow.

Output load transient response / ripple & noise Test

Output load transient response and ripple&noise are measured in figure 13. And the probe ground should be less than 1/2 inch to measure exact data.

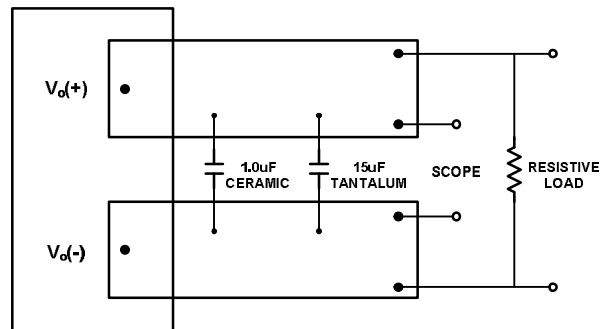

[Fig.30]

Output Impedance

Figure14 is output impedance measurement block diagram. Here we measure output impedance by Introducing small test signal current into the switching power supply output and measuring voltage drop caused by the output impedance to understand the behavior of the power supply when the load fluctuates at high speed or when reactive load is connected.

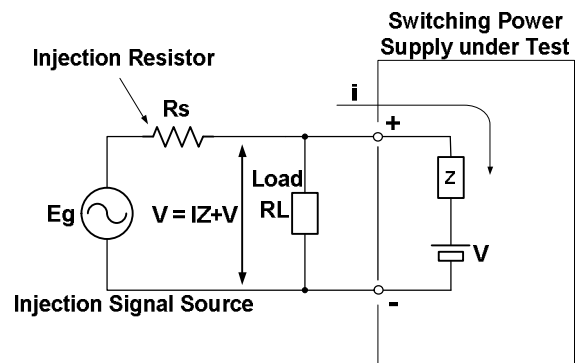

[Fig.31]

General Functions

Remote On/Off Control (CNT)

By using CNT pin you can control the output without turning the input power on or off. This unit is positive-polarity device. Positive-polarity device is enabled when pin is left open or is pulled up to high. And positive-polarity device is disabled when pin2 is pulled down to low with respect to -Vin.

Output voltage variation (Trim)

Output Voltage adjusted by using trim pin within $\pm 10\%$ of output voltage.

Resistors should be located close to the converters. If the trim function is not used, leave the trim pin open. And If \pm sense are used, change from figure15 to figure16.

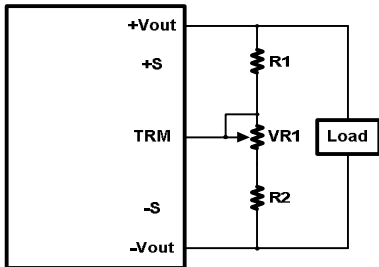

[fig.32]

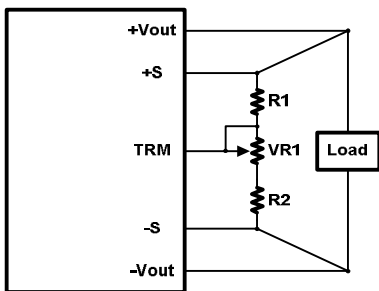

[fig.33]

Output Voltage	VR	R1	R2
3.3V	500Ω	1kΩ	560Ω
5V	1kΩ	1kΩ	680Ω
12V	1kΩ	3.9kΩ	680Ω

Remote Sense

The sense inputs correct for output voltage drops along the conductors that connect the converter's output pins to the load. This output voltage drop should not be allowed to exceed 0.5V. Consider using heavier wire if this drop is excessive.

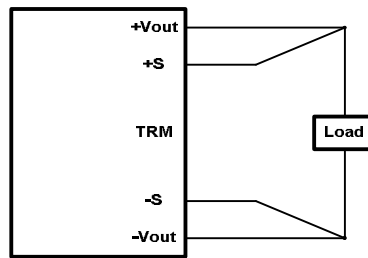

[fig.34]

Over Voltage Protection(OVP)

If the output voltage rises to a fault condition, which could be damaging to the load circuitry, the sensing circuitry will power down the PWM controller causing the output voltage to decrease.

Over current Protection(OCP)

This products built in over current protection circuit which operates when the output current is over 105% of rating and automatically recovers when over current condition is removed.

Over Temperature Shut down(OTP)

The converters are equipped with precision thermal-shutdown circuitry. If the internal temperature of the converter rises up to the designed operating temperature, a precision temperature sensor will power down the unit. When the internal temperature decreases below the threshold of the temperature sensor, the unit will self start.

NHS150-48 Series: Isolated DC/DC Converters
 36 – 75V Input, Maximum Power : 150W

Data Sheet
 Mar. 3, 2008

Mechanical Specification

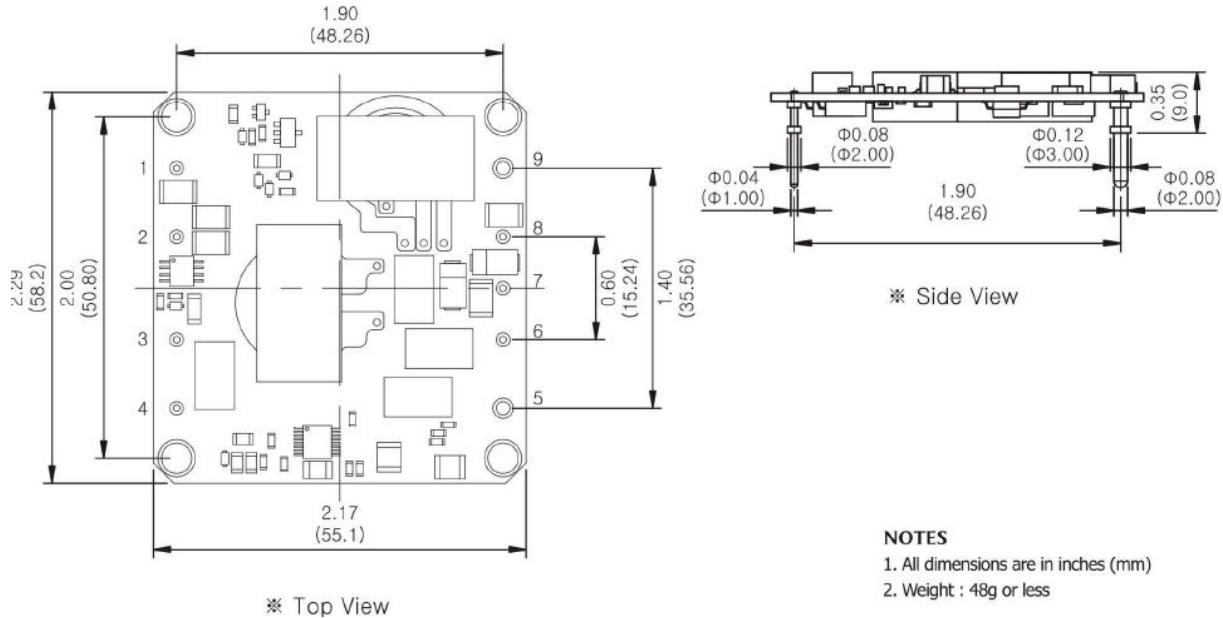

Pin Assignments

PIN NO	NAME	FUNCTION
1	+Vin	Positive Input voltage
2	CNT	Remote ON/OFF
3	Case	Case
4	-Vin	Negative input voltage
5	-Vout	Negative output voltage
6	-Sense	Negative remote sense
7	Trim	Output voltage variation
8	+Sense	Positive remote sense
9	+Vout	Positive output voltage

NHS150-48 Series: Isolated DC/DC Converters
36 – 75V Input, Maximum Power : 150WData Sheet
Mar. 3, 2008**Ordering Information**

Input	Output	Maximum Power	Ripple & Noise Max.	Efficiency Typ.	Model Number
18~36V	3.3V@30A	99W	75mVp-p	89.73%	NHS150-24-3R3
18~36V	5V@30A	150W	75mVp-p	90.14%	NHS150-24-5
18~36V	12V@12.5A	150W	120mVp-p	91.3%	NHS150-24-12
36~75V	3.3V@30A	99W	75mVp-p	90.31%	NHS150-48-3R3
36~75V	5V@30A	150W	75mVp-p	91.05%	NHS150-48-5
36~75V	12V@12.5A	150W	120mVp-p	92.6%	NHS150-48-12

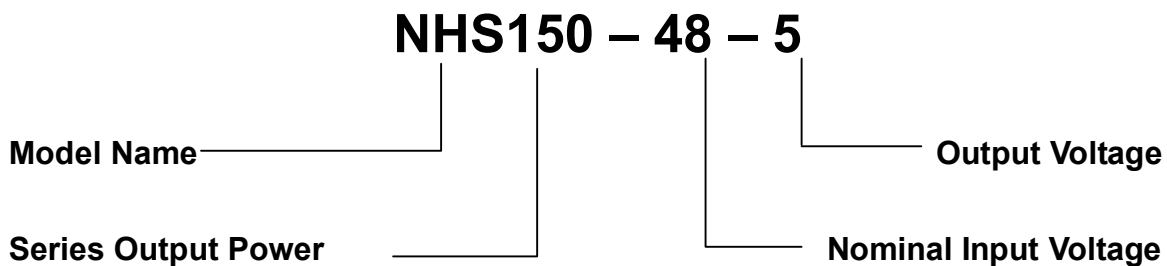
Part Number Structure

No part of this publication may be copied, transmitted, or stored in a retrieval system or reproduced in any way including, but not limited to, photography, photocopy, or other recording means, without prior written permission from Powerplaza co., Ltd

HEAD OFFICE & FACTORY

#1402, 14F/L 6th Daeryung TechnoTown 493-6,
Gasan-Dong, Kumchon-Gu, Seoul, 153-774,
Korea

TEL: +82 2 855 4955 | FAX: +82 2 855 4954

GENERAL SALES INQUIRIES

Please feel free to

contact : sales@powerplaza.co.kr

©2007 Powerplaza co., Ltd. Specification subject to change without notice.