



eFS30 Series – Isolated AC/DC Converters

85 – 264Vac Input, Maximum Power: 30W

Data Sheet
April 9, 2012

eFS30 Series –small size isolated AC/DC converters

Features

- Encapsulated, compact case
- High Efficiency
- Low input current at no load
(0.2W@220VAC)
- Universal input range
- Built in EMI Filter
- Inrush current limit
- Over current protection
- Over voltage protection (Latch)
- Output short circuit protection
- Input – Output Isolated
- Safety agency approval : Pending
UL (UL 60950,CSA C22.2 NO.60950)
CE (EN 60950) through TÜV
- RoHS directive



Applications

- Telecommunication
- Datacom
- Instrumentation
- Distributed Power System

Description

eFS30 Series is a High Efficiency AC/DC Converter that provides up to 30 watts of output power in ultra compact size. This module operate a burst mode below a given output power and it offers a high efficiency at light load. Burst mode occurs below typically 20~25% of rated out power. It can cause an acoustic noise and high output ripple voltage. This module has an over current and over voltage protection mode and wide operating temperature range from -10°C to +50°C.



eFS30 Series – Isolated AC/DC Converters
85 – 264Vac Input, Maximum Power: 30W

Data Sheet
 April 9, 2012

Absolute Maximum Ratings

Parameter	Min	Typ	Max	Unit	Notes
Input Voltage Continuous	85	-	264	VAC	
Operating Ambient Temperature	-10	-	50	°C	
Storage Temperature	-20	-	70	°C	
I/O Isolation Voltage	-	-	3000	VAC	

Stresses in excess of the absolute maximum ratings can cause permanent damage to the device

Electrical Specifications

Input Characteristics

T_A = +25°C, V_{in} = 85 ~ 264VAC After warm up unless otherwise specified

Parameter	Symbol	Min	Typ	Max	Unit
Operating voltage Range		85		264	Vac
Input current (@ 220V / @110V)	I _{in}				A
eFS30-3R3			0.25(0.42)		
eFS30-5			0.34(0.58)		
eFS30-12			0.33(0.56)		
eFS30-15			0.31(0.54)		
eFS30-24			0.31(0.54)		
eFD30-1212			0.34(0.58)		
eFD30-1515			0.34(0.57)		
No load Input Power					W
eFS30-3R3			0.2		
eFS30-5			0.2		
eFS30-12			0.2		
eFS30-15			0.2		
eFS30-24			0.2		
eFD30-1212			0.2		
eFD30-1515			0.2		
Inrush Current@Cold start				30A max 60A max	@110VAC @220VAC
Operating Frequency		47		63	Hz



eFS30 Series – Isolated AC/DC Converters
85 – 264Vac Input, Maximum Power: 30W

Data Sheet
 April 9, 2012

Output Characteristics

T_A = +25°C, V_{in} = 85 ~ 264VAC After warm up unless otherwise specified

Parameter	Symbol	Min	Typ	Max	Unit
Output Voltage tolerance	V _o	-	-	±2	%
Output Current	I _o				
eFS30-3R3				6	A
eFS30-5				6	A
eFS30-12				2.5	A
eFS30-15				2.0	A
eFS30-24				1.25	A
eFD30-1212				±1.25	A
eFD30-1515				±1	A
Output Regulation;					
- Line Regulation (From minimum input voltage to maximum input voltage, constant load)		-	-	±1	%
- Load Regulation (From no load to maximum load, Constant load)		-	-	±1	%
Output Current Limit (Automatic recovery)		>105			%
Output Ripple and noise (V _{in} = 24V, and I _o = Max Output Current Bandwidth 20MHz, 1uF Ceramic cap)	mVp-p	-	1% of V _{out}		mV
Efficiency					
eFS30-3R3			77		%
eFS30-5			81		%
eFS30-12			86		%
eFS30-15			87		%
eFS30-24			88		%
eFD30-1212			87		%
eFD30-1515			87		%

**eFS30 Series – Isolated AC/DC Converters**

Data Sheet

85 – 264Vac Input, Maximum Power: 30W

April 9, 2012

(100% of max Io, Vin = 220VAC)					
Dynamic Load Response (1uF Ceramic 25% to 50 %, 50% to 25%, Slew rate = 0.05A/us)			±	3% of Output Voltage	mV
Start – Up Time		-	-	400	ms
Hold – Up Time				10	ms
Turn – on overshoot		-	-	1	%
Maximum output capacitance					μF

Isolation Specifications

Parameter	Symbol	Min	Typ	Max	Unit
I/O Isolation Voltage (AC500V, 1 Min)					
- Input-Output:			-	3000	VAC
- Input-Case:			-	3000	VAC
- Output-case:			-	1500	VAC
Isolation Resistance - Output-Case (at DC500V at 25°C And 70%RH for 1 min)	RISO	>100	-	-	MΩ
Isolation Capacitance	CISO				pF

General Specifications

Parameter	Symbol	Min	Typ	Max	Unit
Switching Frequency			67		KHz
MTBF (MiL-HDBK- 217F)			6.6 x 10 ⁵		hrs
Dimensions (W.H.L)			53 x 21.5 x 94		mm
Weight			200		Grams



eFS30 Series – Isolated AC/DC Converters
85 – 264Vac Input, Maximum Power: 30W

Data Sheet
April 9, 2012

Environmental

Parameter	Symbol	Min	Typ	Max	Unit
Operating Temperature		-10		50	°C
Operating Humidity (RH non-condensing)		5		95	%
Storage Temperature		-20		70	°C
Vibration @10G(98m/s ²)		10		55	Hz

Characteristic Curves
Efficiency Curves

Vin=220VAC, Vo=12@2.5, At 25°C

eFS30-3R3

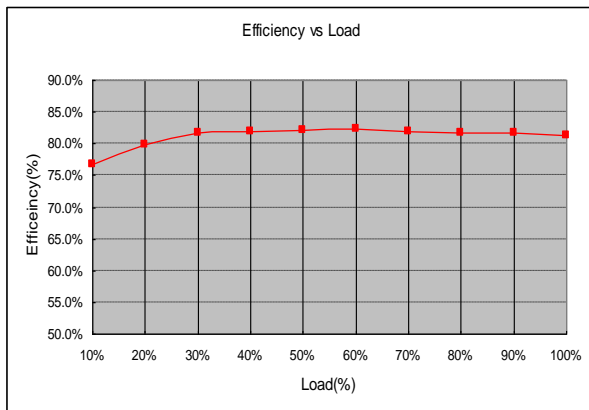

Vin=220VAC, Vo=3.3V@6A, At 25°C

eFS30-5

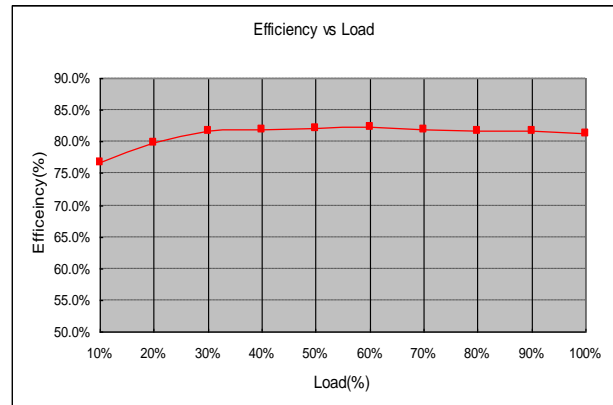

Vin=220VAC, Vo=5V@6A, At 25°C

eFS30-12

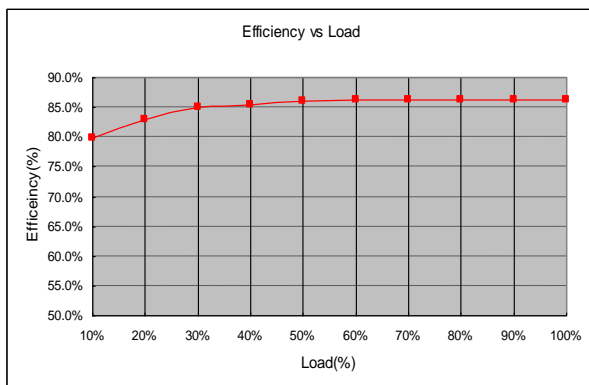

eFS30-15



eFS30 Series – Isolated AC/DC Converters 85 – 264Vac Input, Maximum Power: 30W

Data Sheet
April 9, 2012

Vin=220VAC, Vo=24V @ 1.25A , At 25°C

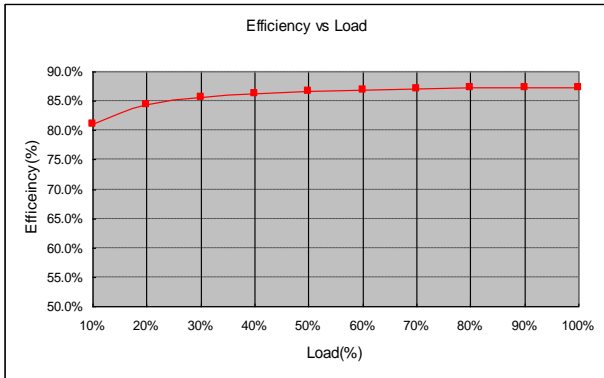

Vin=220VAC, Vo=15V@2A , At 25°C

Efficiency Curves

eFS30-24

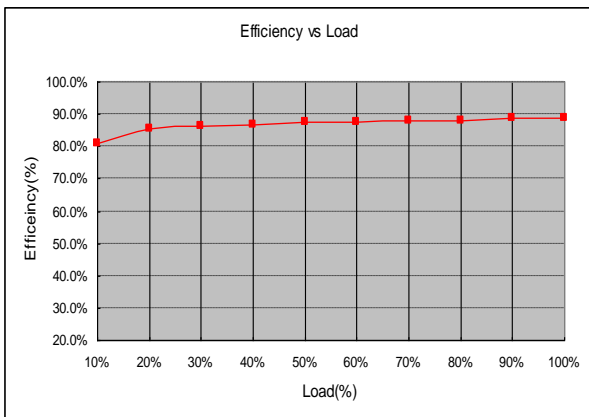

eFD30-1515

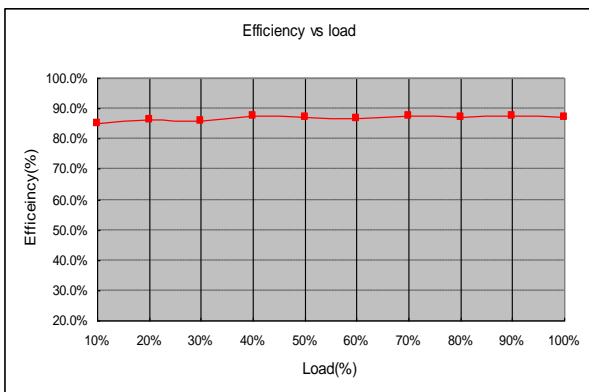

eFD30-1212

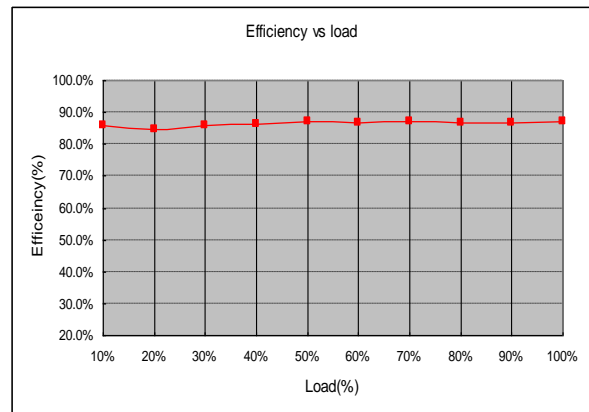

Vin=220VAC, Vo=±12V @ 1.25A , At 25°C

Vin=220VAC, Vo=±15V @ 1.0A , At 25°C



eFS30 Series – Isolated AC/DC Converters

85 – 264Vac Input, Maximum Power: 30W

Data Sheet
April 9, 2012

eFS30-12

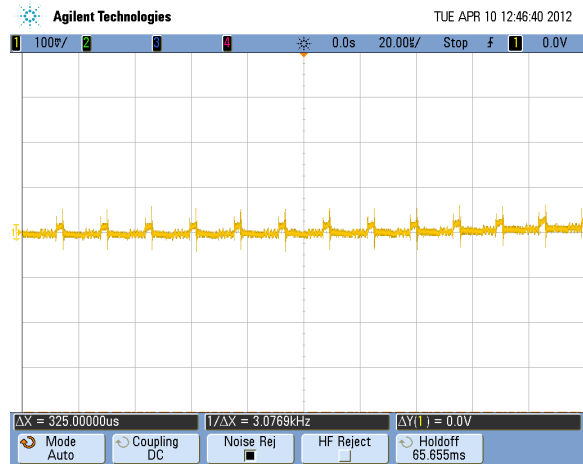

Vin=220VAC, Vo=12V @2.5A , At 25°

Output Ripple & Noise

eFS30-3R3

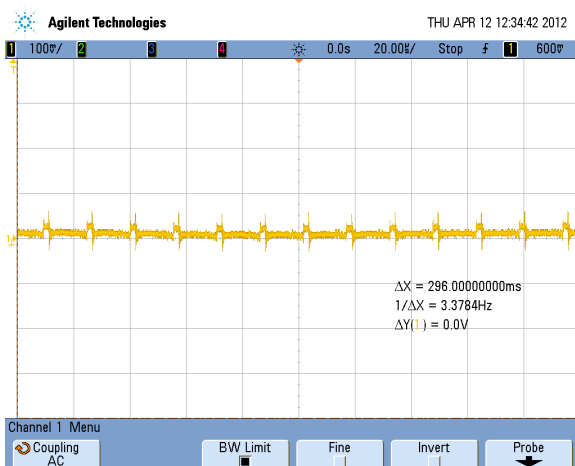

Vin=220VAC, Vo=3.3V @6A , At 25°

eFS30-5

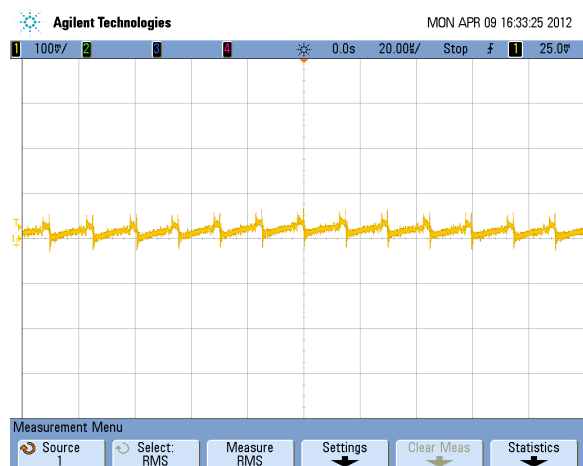

Vin=220VAC, Vo=5V @6A , At 25°



eFS30 Series – Isolated AC/DC Converters

85 – 264Vac Input, Maximum Power: 30W

eFS30-15

Data Sheet
April 9, 2012

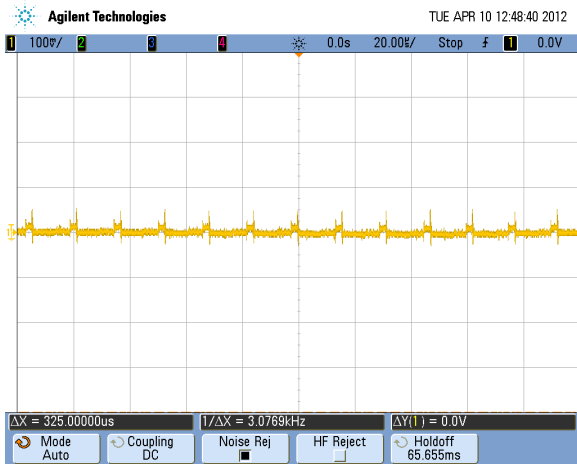

Vin=220VAC, Vo=15V@2A, At 25°

Output Ripple & Noise

eFS30-24

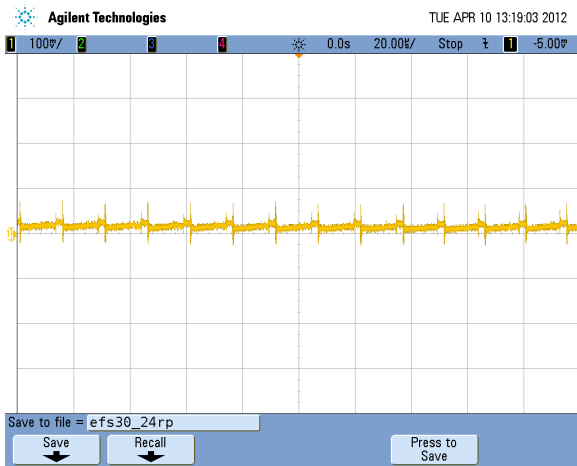

Vin=220VAC, Vo=24V@1.25A, At 25°

eFD30-1515

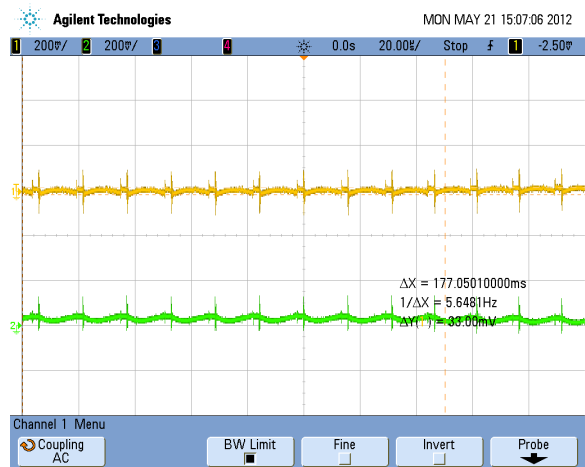

eFD30-1212



eFS30 Series – Isolated AC/DC Converters

85 – 264Vac Input, Maximum Power: 30W

Data Sheet
April 9, 2012

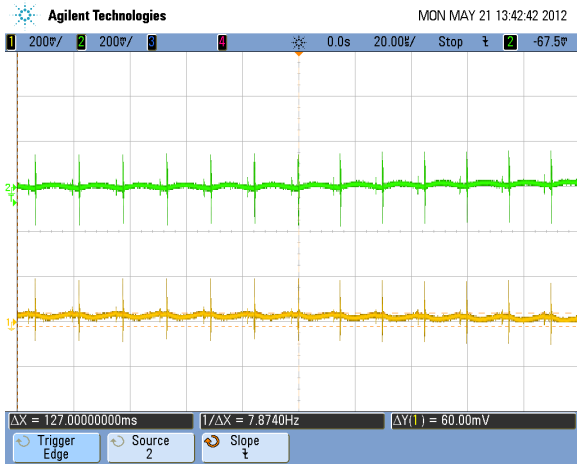

Vin=220VAC, Vo=±12V@1.25A , At 25°C

Vin=220VAC, Vo=±15V@1.0A , At 25°C

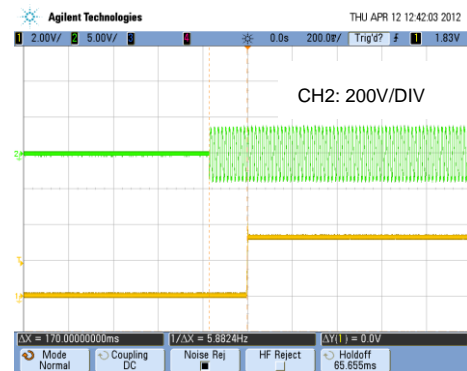

Vin=220VAC, Vo=3.3V @6A , At 25°C

eFS30-12

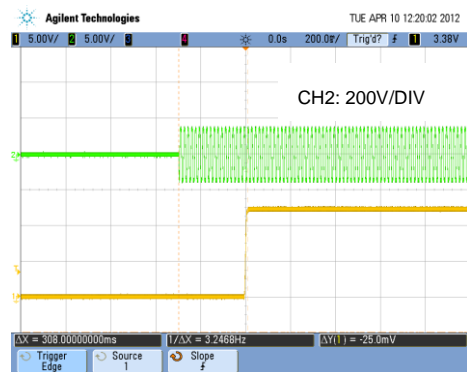

Vin=220VAC, Vo=12V @2.5A , At 25°C

eFS30-24

Start-up Time

eFS30-3R3



eFS30 Series – Isolated AC/DC Converters

85 – 264Vac Input, Maximum Power: 30W

Data Sheet
April 9, 2012

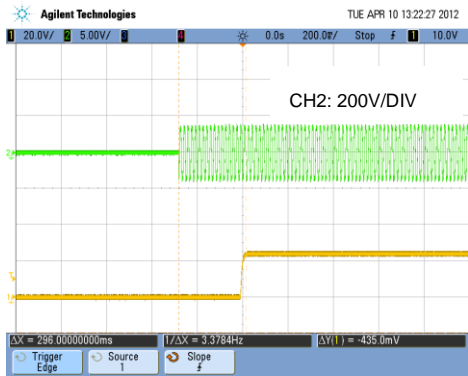

Vin=220VAC, Vo=24V @1.25A, At 25°C

eFS30-15

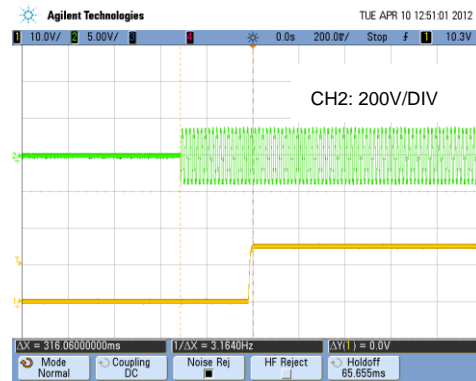

Vin=220VAC, Vo=15V @2A, At 25°C

eFS30-5

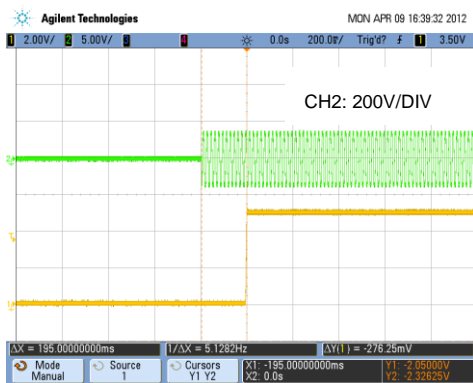

Vin=220VAC, Vo=5V @6A, At 25°C

Hold Up Time

eFS30-3R3

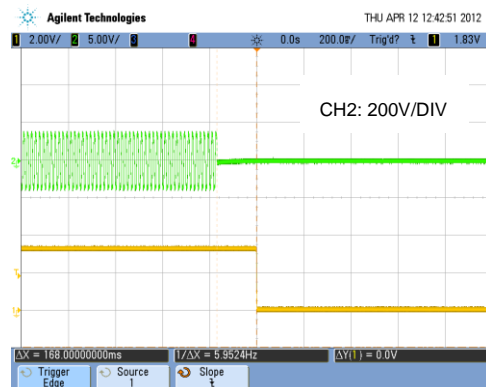

Vin=220VAC, Vo=3.3V @6A, At 25°C

eFS30-12



eFS30 Series – Isolated AC/DC Converters

85 – 264Vac Input, Maximum Power: 30W

Data Sheet
April 9, 2012

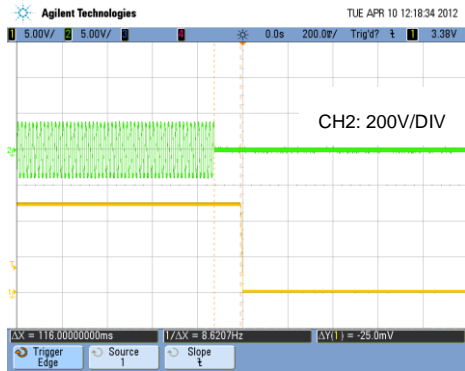

Vin=220VAC, Vo=12V @2.5A , At 25°C

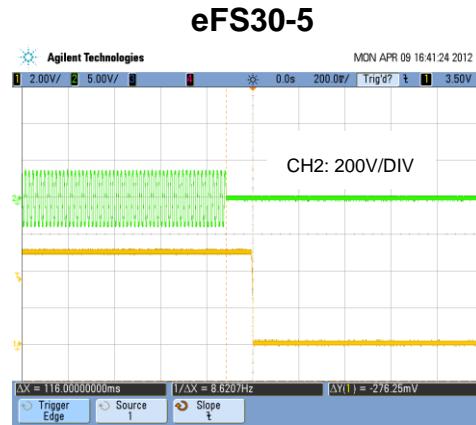

Vin = 220VAC, Vo=5V @6A, At 25°C

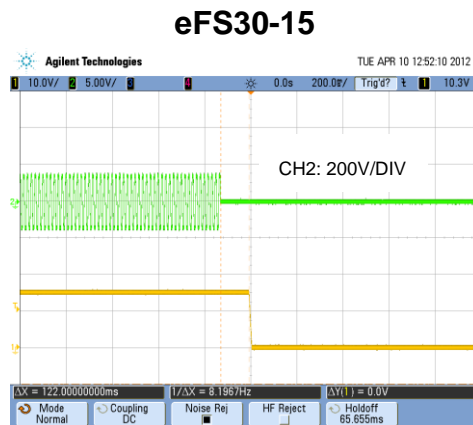

Vin=220VAC, Vo=15V @2A, At 25°C

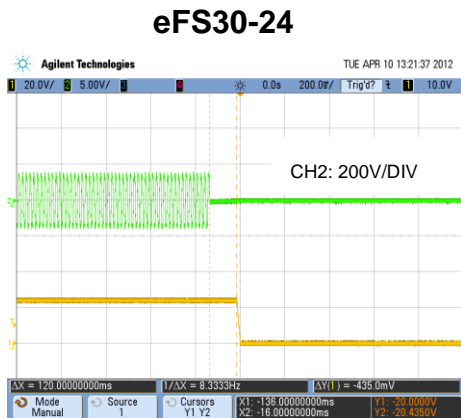

Vin=220VAC, Vo=24V @1.25A , At 25°C

Output Load Transient Response

(Dynamic load change from 25% to 50% of full load, slew rate = 0.1A/us)

eFS30-3R3



eFS30 Series – Isolated AC/DC Converters

85 – 264Vac Input, Maximum Power: 30W

Data Sheet
April 9, 2012

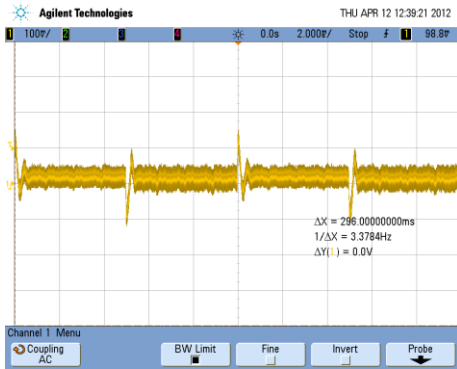

Vin=220VAC , At 25°C

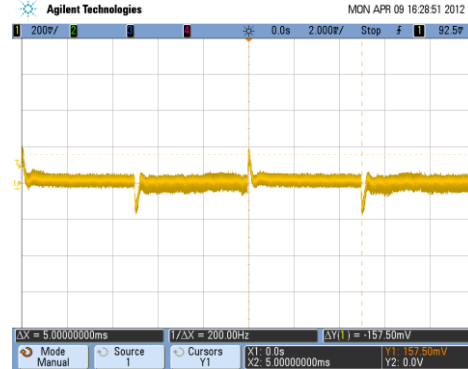

Vin=220VAC, At 25°C

eFS30-12

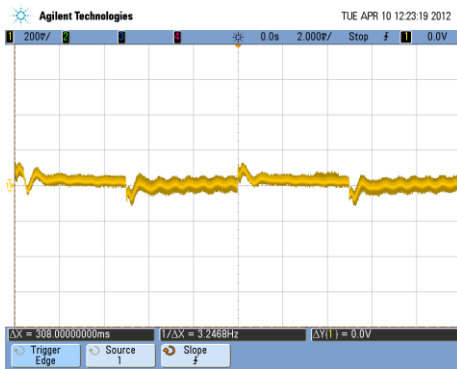

Vin = 220VAC, At 25°C

eFS30-15

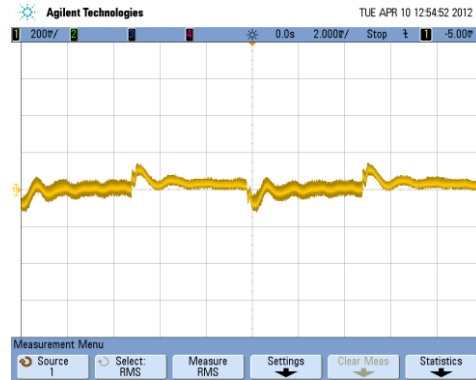

Vin=220VAC, At 25°

eFS30-24



Vin=220VAC, At 25°

eFS30-5

Basic connection

Instruction manual

eFS30 Series – Isolated AC/DC Converters

85 – 264Vac Input, Maximum Power: 30W

Data Sheet
April 9, 2012

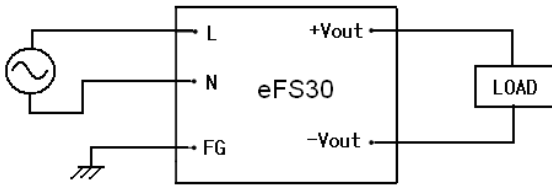

outputs of two or more power supplies, as shown below. Output current in series connection should be lower than the lowest current in each unit. (Please use schottky barrier diode)

Output ripple and noise Test

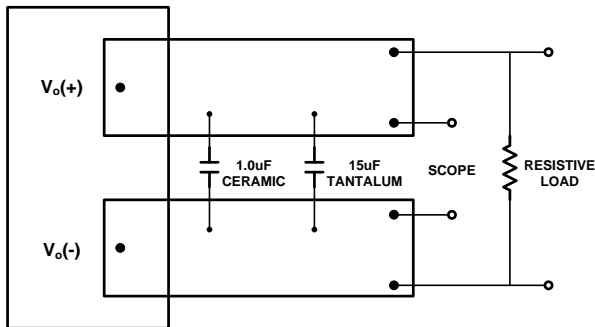

* Conductor from Vout-pins to capacitors = 50mm (1.97in)

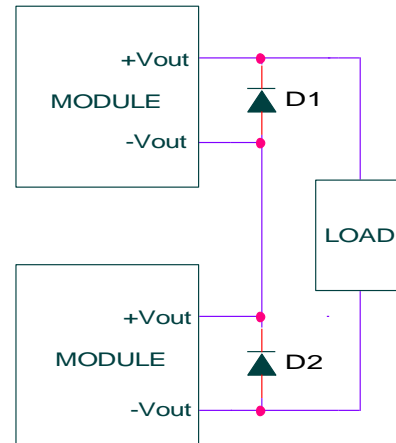

Parallel operation

Parallel operation is available by connecting the units as shown below.

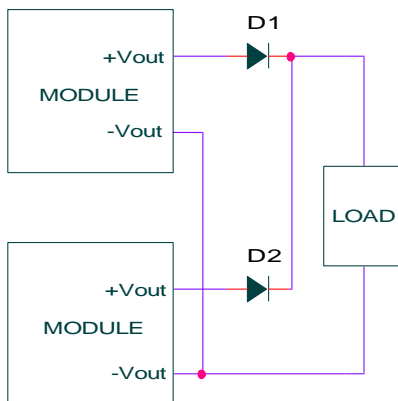

Thermal Considerations

eFS30 series has wide operating temperature range from -10°C to $+50^{\circ}\text{C}$.

However, it should be required a enough air flow for more reliable operation. Output derating curve provide designers with a quantity of a current under the desired ambient temperature and velocity of a airflow.

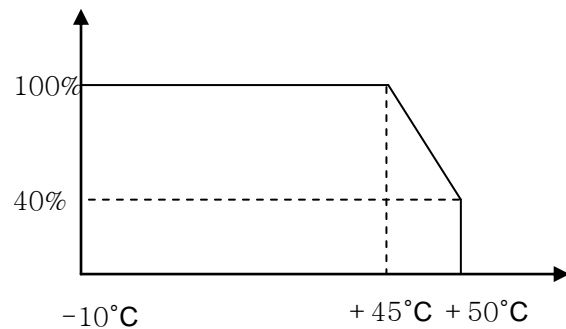

Series operation

Series operation is available by connecting the

Feature Description

eFS30 Series – Isolated AC/DC Converters

85 – 264Vac Input, Maximum Power: 30W

Data Sheet
April 9, 2012

Input Fuse

In order to comply with safety requirements, eFS30 series has a fuse built in.

Input Output Filter

eFS30 series have an internal EMI filter. To reduce conducted noise, additional external input filter is required

To reduce a output ripple and noise, external capacitor is required at the output of the device

Over current Protection (OCP)

eFS30 series built in over current protection circuit which operates when the output current is over 105% of rating and automatically recovers when over current condition is removed

If the short or overload condition continues, the power module could be damaged.

Over Voltage Protection (OVP)

eFS30 series built in overvoltage protection circuit. When the OVP trigger, the output will be shut down. The input must be taken out(for at least five seconds), and than re-inputted manually. Otherwise, the module will not operate.

Soldering Information

The product is intended for through hole mounting in a PCB, When wave soldering is used, the temperature on the pins is specified to maximum 260°C for maximum 10 seconds when hand soldering, care should be taken to avoid direct contact between the hot soldering iron tip and the pins for more than a few seconds in order to prevent overheating.

EMI Characteristic (conducted Emission)

In order to reduce conducted noise install an external input filter as shown in below.

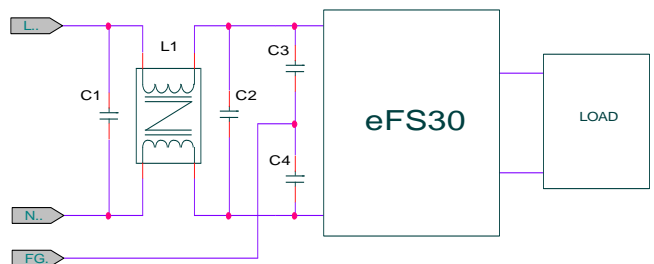

Model Number	L1	C1	C2	C3,C4
eFS30-12	10mH	330nF	1uF	2200pF

Complies with CISPR 22 CLASS B

**eFS30 Series – Isolated AC/DC Converters**
85 – 264Vac Input, Maximum Power: 30WData Sheet
April 9, 2012**Pin assignments**

TOP VIEW

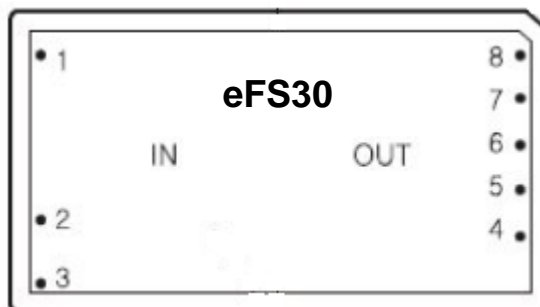
**Single Output**

PIN NO	NAME	FUNCTION
1	FG	Frame Ground
2	AC(L)	AC Input
3	AC(N)	AC Input
4	NC	No connection
5	No pin	
6	+Vout	Positive side of output voltage
7	No pin	
8	-Vout	Negative side of output voltage

Dual Output

PIN NO	NAME	FUNCTION
1	FG	Frame Ground
2	AC(L)	AC Input
3	AC(N)	AC Input
4	No pin	
5	+Vout	Positive side of output voltage
6	COM	Common ground
7	-Vout	Negative side of output voltage
8	No pin	

eFS30 Series – Isolated AC/DC Converters

85 – 264Vac Input, Maximum Power: 30W

Data Sheet
April 9, 2012

Mechanical Specification

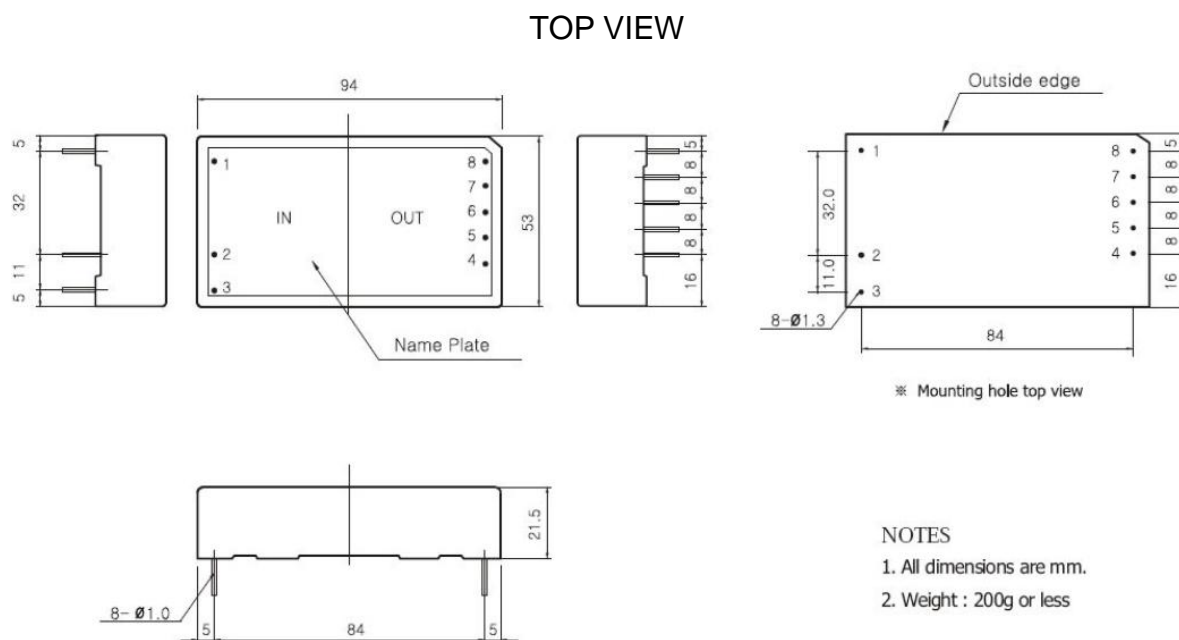

Ordering Information

Input	Output1, Output2	Maximum Power	Ripple & Noise Typ.	Efficiency Typ.	Model Number
85 – 264V	3.3V@6A	19.8W	80mVp-p	77%	eFS30-3R3(C)
	5V@6A	30W	80mVp-p	81%	eFS30-5(C)
	12V@2.5A	30W	120mVp-p	86%	eFS30-12(C)
	15V@2A	30W	150mVp-p	87%	eFS30-15(C)
	24V@1.25A	30W	240mVp-p	88%	eFS30-24(C)
	+12V@1.25A, -12V@1.25A	30W	120mVp-p	87%	eFD30-1212(C)
	+15V@1A, -15V@1A	30W	150mVp-p	87%	eFD30-1515(C)

* (C): Chassis mount type



eFS30 Series – Isolated AC/DC Converters
85 – 264Vac Input, Maximum Power: 30W

Data Sheet
April 9, 2012

Part number structure

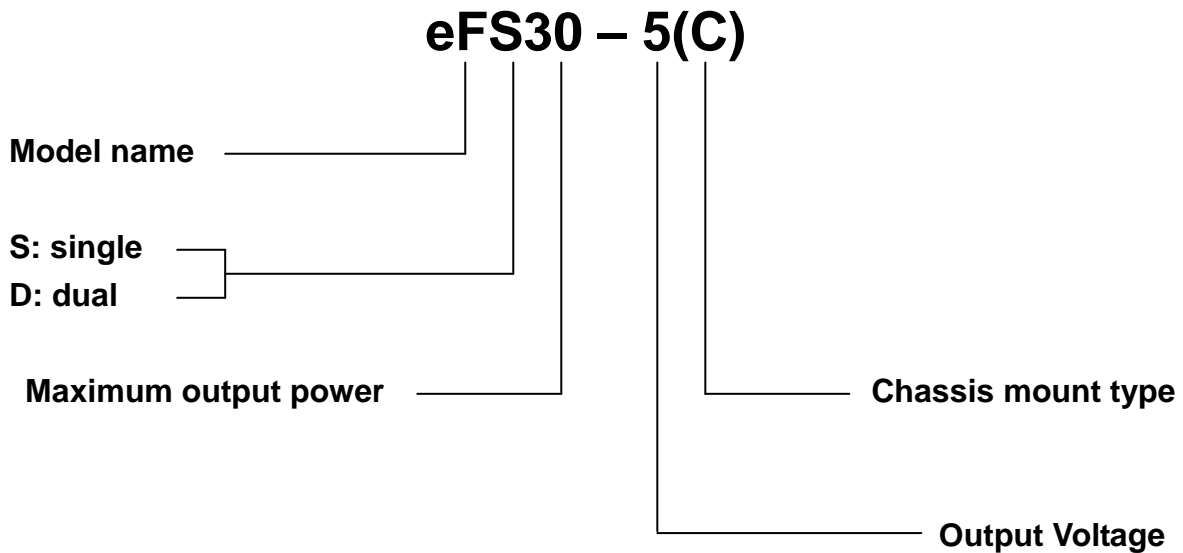

No part of this publication may be copied, transmitted, or stored in a retrieval system or reproduced in any way including, but not limited to, photography, photocopy, or Other recording means, without prior written permission from Powerplaza co.,Ltd



HEAD OFFICE & FACTORY

#1401, 14F/L 6th Daeryung TechnoTown 493-6,
Gasam-Dong, Kumchon-Gu, Seoul, 153-803,
Korea
TEL: +82 2 855 4955 | FAX: +82 2 855 4954

GENERAL SALES INQUIRIES

Please feel free to
contact : sales@powerplaza.co.kr

©2011 Powerplaza co.,Ltd. Specification subject to change without notice