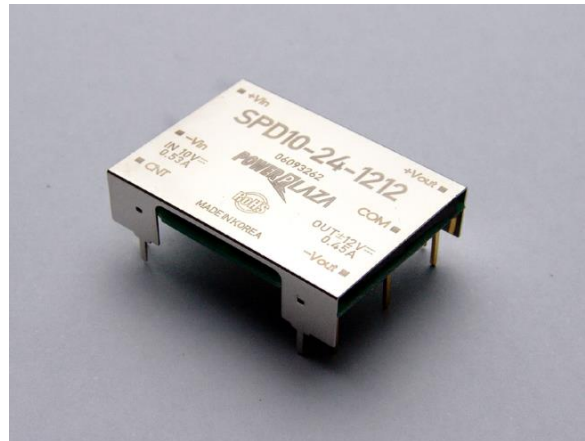

**FS60 Series – Isolated AC/DC Converters**
85 - 264Vac Input, Maximum Power: 60WData Sheet
June 1, 2011**FS60 Series –small size isolated AC/DC converters****Features**

- High Efficiency
- Wide operating temperature range
(-10°C to +60°C)
- Universal input range
- Built in EMI Filter
- Inrush current limit
- Over current protection
- Over voltage protection
- Output short circuit protection
- Input – Output Isolated
- Safety agency approval : Pending
UL (UL 60950,CSA C22.2 NO.60950)
CE (EN 60950) through TÜV
- RoHS directive

**Applications**

- Telecommunication
- Datacom
- Instrumentation
- Distributed Power System

Description

FS60 Series is a High Efficiency AC/DC Converter that provides up to 60 watts of output power in ultra compact size. This module offers a cost effective solution for many space critical applications. Quasi- Resonant Flyback Topology is applied to achieve a high efficiency. It has a wide operating temperature from -10°C to +60°C and internal EMI Filter is employed for reduced noise level.

Absolute Maximum Ratings

**FS60 Series – Isolated AC/DC Converters**
85 - 264Vac Input, Maximum Power: 60WData Sheet
June 1, 2011

Parameter	Min	Typ	Max	Unit	Notes
Input Voltage Continuous	85	-	264	VAC	
Operating Ambient Temperature	-10	-	60	°C	
Storage Temperature	-20	-	70	°C	
I/O Isolation Voltage	-	-	3000	VAC	

Stresses in excess of the absolute maximum ratings can cause permanent damage to the device

Electrical Specifications

Input Characteristics

Parameter	Symbol	Min	Typ	Max	Unit
Operating voltage Range		85		264	Vac
Maximum Input current (At nominal input voltage and Maximum Output Power)	I_{in}		0.69		A (@12V)
No load Input Power					W
FS60-5			0.3		
FS60-12			0.4		
FS60-15			0.5		
FS60-24			0.5		
FSD60-1212			0.4		
FSD60-1515			0.3		
Inrush Current@Cold start				30A max 60A max	@110VAC @220VAC
Operating Frequency		47		63	Hz

Output Characteristics

**FS60 Series – Isolated AC/DC Converters**
85 - 264Vac Input, Maximum Power: 60WData Sheet
June 1, 2011T_A = +25°C V_{in} = 85 ~ 264VAC unless otherwise specified

Parameter	Symbol	Min	Typ	Max	Unit
Output Voltage tolerance	V _o	-	-	±2	%
Output Current	I _o				
FS60-5				10	A
FS60-12				5.0	A
FS60-15				4.0	A
FS60-24				2.5	A
FSD60-1212				±2.5	A
FSD60-1515				±2	A
Output Regulation; - Line Regulation (From minimum input voltage to maximum input voltage, constant load)		-	-	±1	%
- Load Regulation (From no load to maximum load, Constant load)		-	-	±1	%
Output Current Limit (Automatic recovery)		>105			%
Output Ripple and noise (V _{in} = 24V, and I _o = Max Output Current Bandwidth 20MHz, 1uF Ceramic cap)	mVp-p	-	1% of V _{out}		mV
Efficiency					
FS60-5			83		%
FS60-12			87		%
FS60-15			87		%
FS60-24			89		%
FSD60-1212			87		%
FSD60-1515			88		%
(100% of max I _o , V _{in} = 220VAC)					
Dynamic Load Response (1uF Ceramic 25% to 50 %, 50% to 25%, Slew rate = 0.05A/us)			±	3% of Output Voltage	mV

FS60 Series – Isolated AC/DC Converters
85 - 264Vac Input, Maximum Power: 60W

 Data Sheet
 June 1, 2011

Start – Up Time		-	-	400	ms
Hold – Up Time				10	ms
Turn – on overshoot		-	-	1	%
Maximum output capacitance					μ F

Isolation Specifications

Parameter	Symbol	Min	Typ	Max	Unit
I/O Isolation Voltage (AC500V, 1 Min)					
- Input-Output:			-	3000	VAC
- Input-Case:			-	3000	VAC
- Output-case:			-	1500	VAC
Isolation Resistance - Output-Case (at DC500V at 25°C And 70%RH for 1 min)	RISO	>100	-	-	M Ω
Isolation Capacitance	CISO				pF

General Specifications

Parameter	Symbol	Min	Typ	Max	Unit
Switching Frequency		65		100	KHz
MTBF (MiL-HDBK- 217F)		5.3 x 10 ⁵			hrs
Dimensions (W.H.L)		57.8 x 32.8 x 130			mm
Weight			260		Grams

Environmental

Parameter	Symbol	Min	Typ	Max	Unit
Operating Temperature		-10		60	°C
Operating Humidity (RH non-condensing)		5		95	%
Storage Temperature		-20		70	°C



FS60 Series – Isolated AC/DC Converters
85 - 264Vac Input, Maximum Power: 60W

Data Sheet
June 1, 2011

Vibration @10G(98m/s ²)	10	55	Hz
-------------------------------------	----	----	----

Characteristic Curves
Efficiency Curves

FS60-5

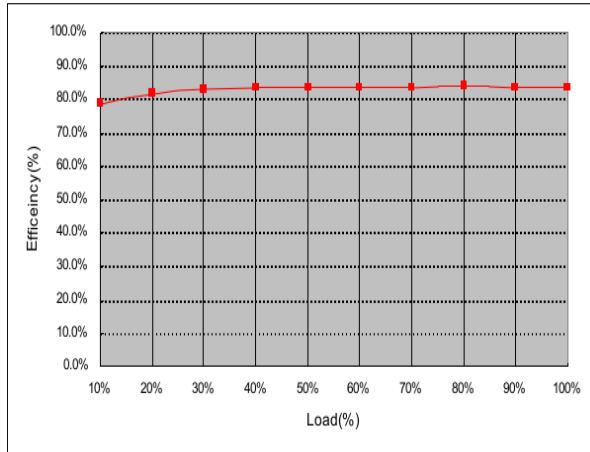

Vin=220VAC, Vo=5V@10A , At 25°C

FS60-12

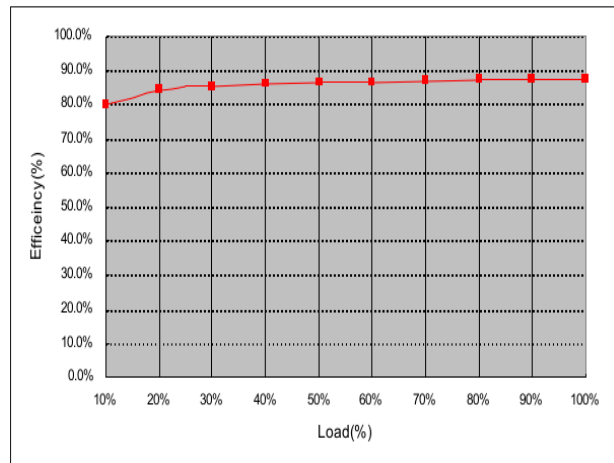

Vin=220VAC, Vo=12V@5A , At 25°C

FS60-15

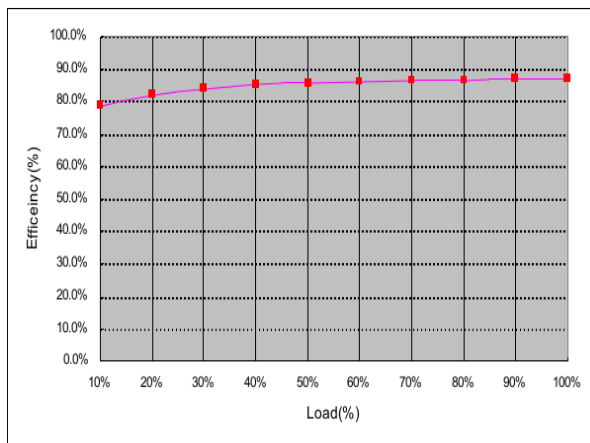

Vin=220VAC, Vo=15V@4A , At 25°C

FS60-24

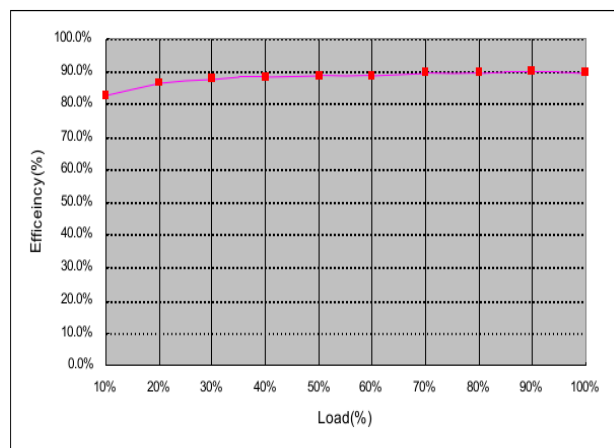

Vin=220VAC, Vo=24V@2.5A , At 25°C

Input Voltage vs Input Power



FS60 Series – Isolated AC/DC Converters
85 - 264Vac Input, Maximum Power: 60W

Data Sheet
June 1, 2011

FS60-5

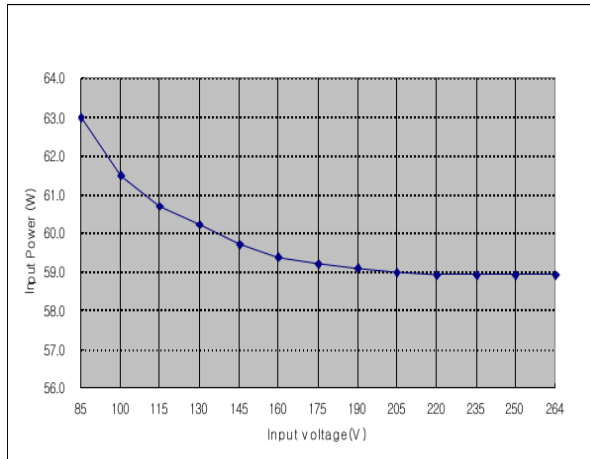

$I_o = 10A$, At 25°C

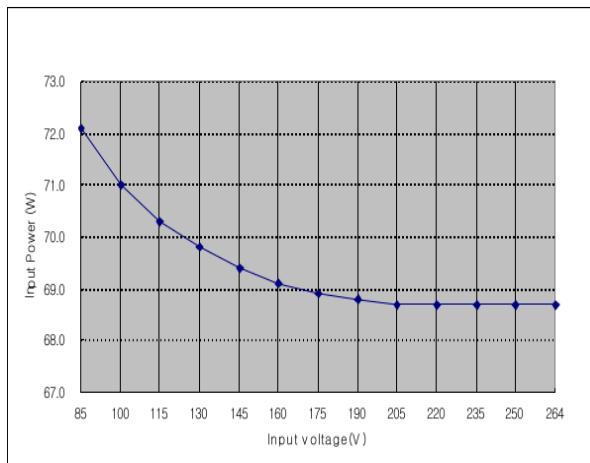

$I_o = 5A$, At 25°C

FS60-15

FS60-12

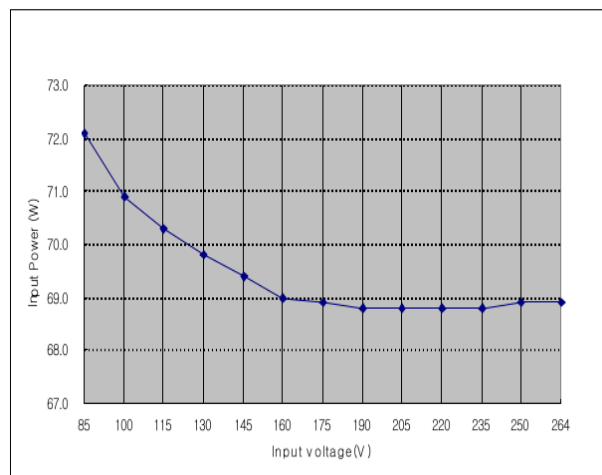

$I_o = 4A$, At 25°C

FS60-24



FS60 Series – Isolated AC/DC Converters 85 - 264Vac Input, Maximum Power: 60W

Data Sheet
June 1, 2011

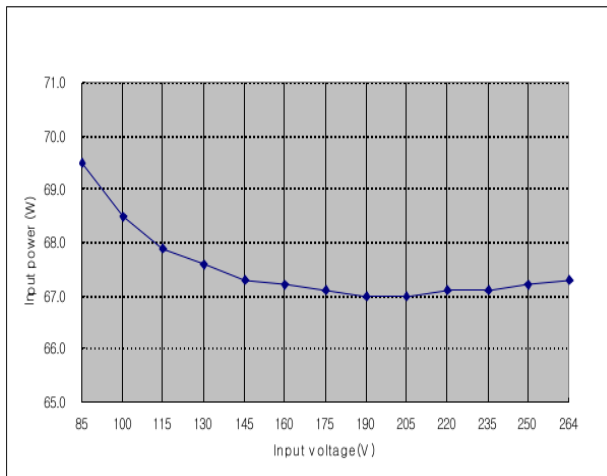

Io =2.5A, At 25°C

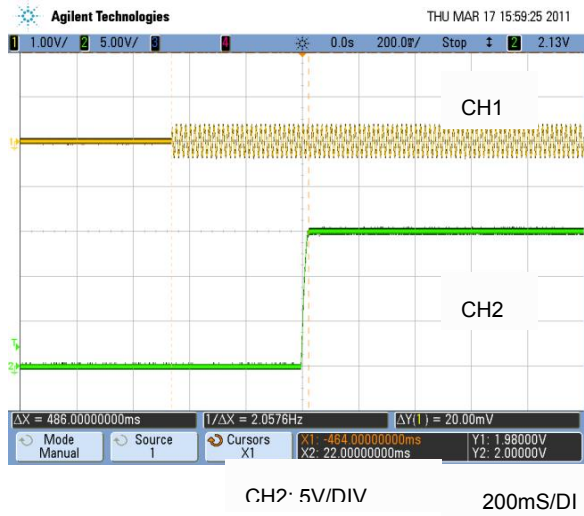

Vin = 110VAC, Vo=15V @4A, At 25°C

Start-up Time

FS60-5



Vin=110VAC, Vo=5V @10A, At 25°C

FS60-12

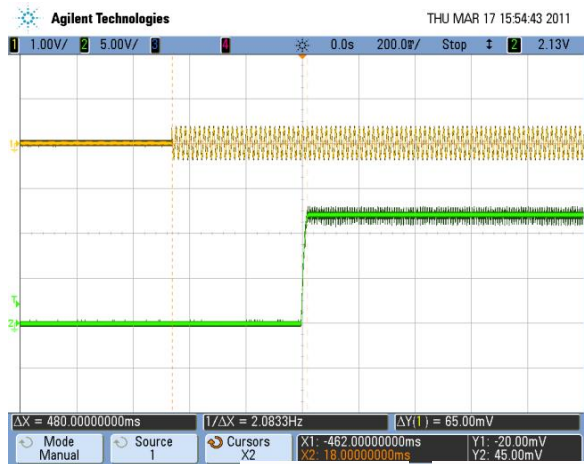

Vin=110VAC, Vo=12V @5A, At 25°C

FS60-15

FS60-24



FS60 Series – Isolated AC/DC Converters 85 - 264Vac Input, Maximum Power: 60W

Data Sheet
June 1, 2011

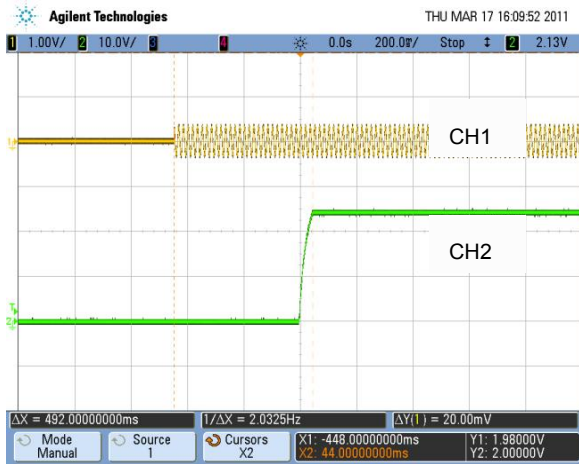

Vin = 110VAC, Vo=24V @2.5A, At 25°

Hold Up Time CH2 : 10V/DIV 200mS/DIV

FS60-5

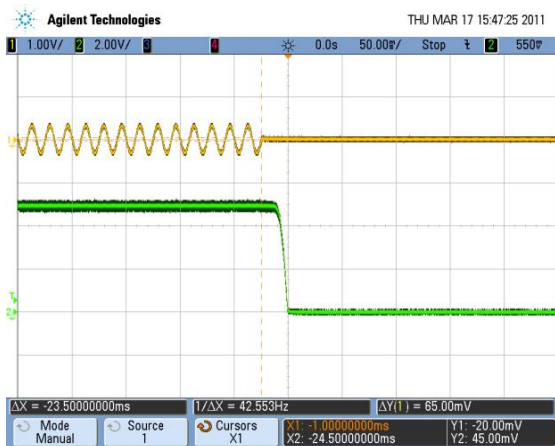

CH1: 2V/DIV 50ms/DIV

Vin=110VAC, Vo=5V @10A , At 25°C

FS60-15

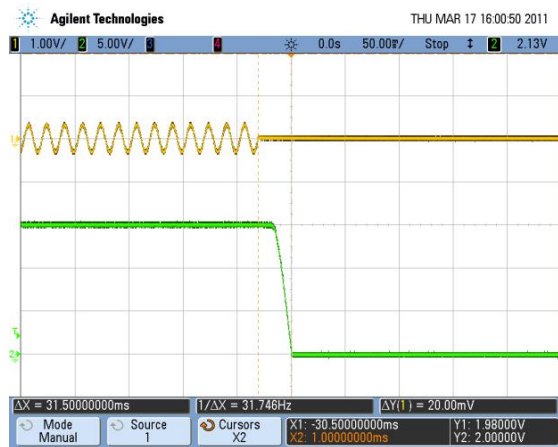

CH1: 5V/DIV 50ms/DIV

Vin=110VAC, Vo=15V @4A , At 25°C

FS60-12



FS60 Series – Isolated AC/DC Converters 85 - 264Vac Input, Maximum Power: 60W

Data Sheet
June 1, 2011

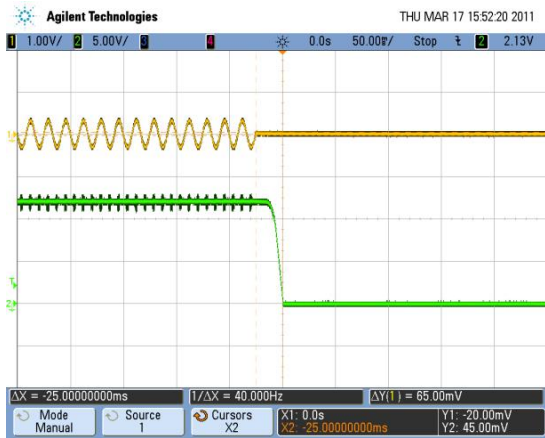

Vin=110VAC, Vo=24V @2.5A, At 25°C

CH1: 5V/DIV 50ms/DIV

Vin = 110VAC, Vo=12V @5A, At 25°C

FS60-24



CH1: 100mV/DIV

10us/DIV

Output Load CH1: 10V/DIV 50ms/DIV

(Dynamic load change from 25% to 50% of full load, slew rate = 0.1A/us)

FS60-5

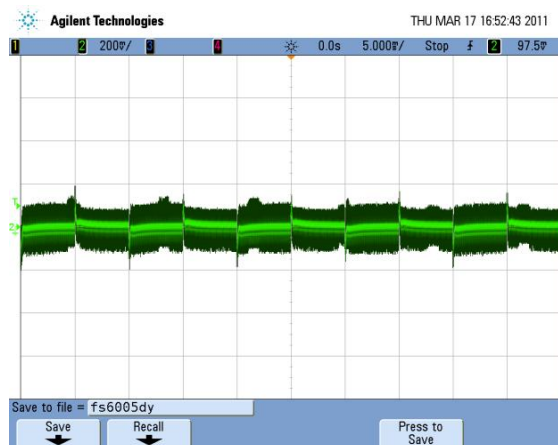

CH1: 200mV/DIV

5ms/DIV



FS60 Series – Isolated AC/DC Converters

85 - 264Vac Input, Maximum Power: 60W

Data Sheet
June 1, 2011

Vin=220VAC , At 25°C

Vin=220VAC, At 25°C

FS60-15

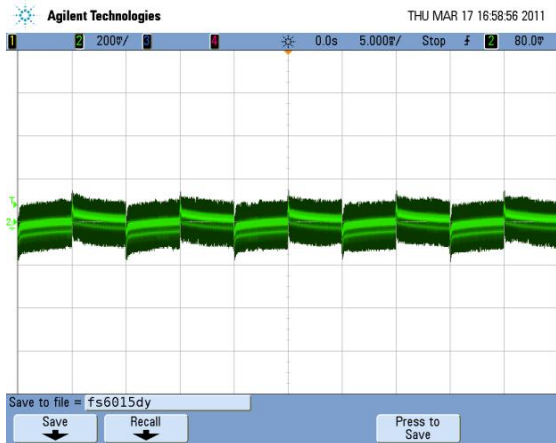

CH1: 200mV/DIV 5ms/DIV

Vin = 220VAC, At 25°C

FS60-24

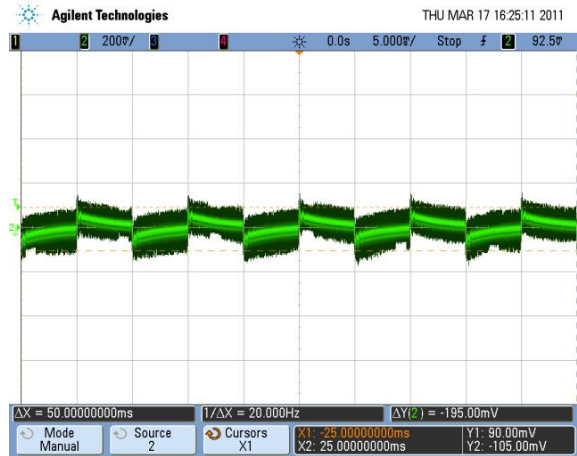

CH1: 200mV/DIV 5ms/DIV

Vin=220VAC, At 25°C

FS60-12

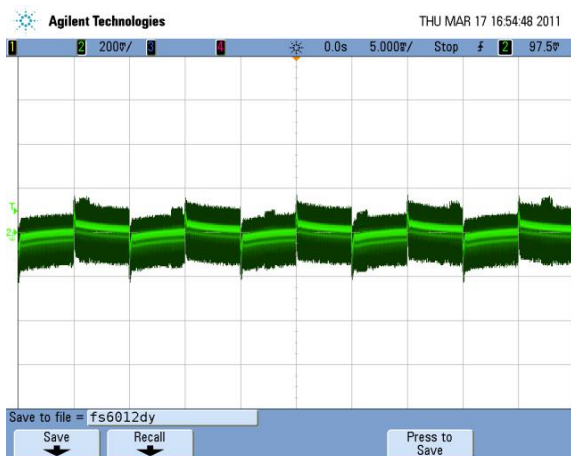

CH1: 200mV/DIV 5ms/DIV

Instruction manual

FS60 Series – Isolated AC/DC Converters

85 - 264Vac Input, Maximum Power: 60W

Data Sheet
June 1, 2011

Basic connection

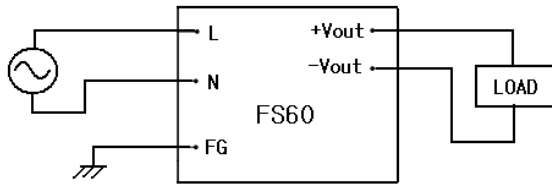

outputs of two or more power supplies, as shown below. Output current in series connection should be lower than the lowest current in each unit. (Please use schottky barrier diode)

Output ripple and noise Test

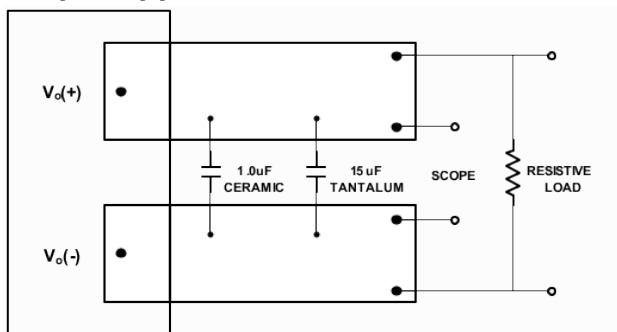

* Conductor from Vout-pins to capacitors = 50mm (1.97in)

Parallel operation

Parallel operation is available by connecting the units as shown below.

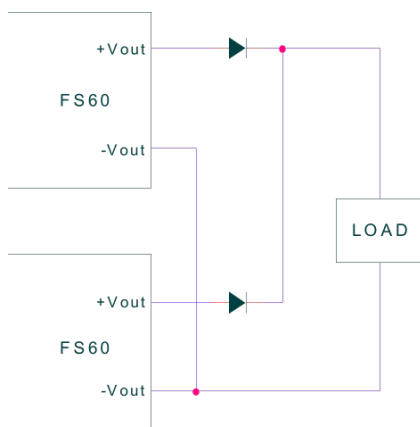

Series operation

Series operation is available by connecting the

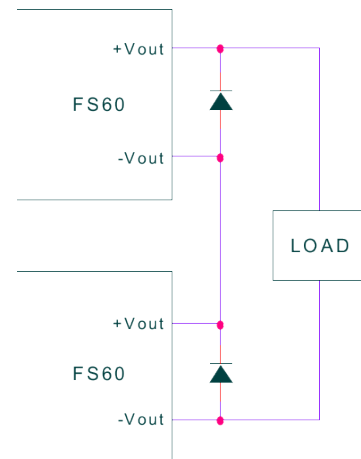

Thermal Considerations

FS60 series has wide operating temperature range from -10°C to $+60^{\circ}\text{C}$.

However, it should be required a enough air flow for more reliable operation. Output derating curve provide designers with a quantity of a current under the desired ambient temperature and velocity of a airflow.

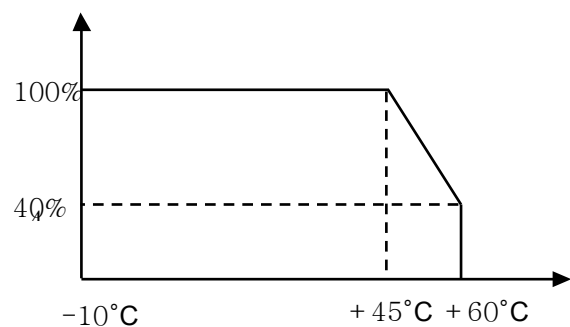

Feature Description



FS60 Series – Isolated AC/DC Converters
85 - 264Vac Input, Maximum Power: 60W

Data Sheet
June 1, 2011

Input Fuse

In order to comply with safety requirements, FS60 series has a fuse built in.

Input Output Filter

FS60 series have an internal EMI filter. To reduce conducted noise, additional external input filter is required

To reduce a output ripple and noise, external capacitor is required at the output of the device

Over current Protection (OCP)

FS60 series built in over current protection circuit which operates when the output current is over 105% of rating and automatically recovers when over current condition is removed

If the short or overload condition continues, the power module could be damaged.

Over Voltage Protection (OVP)

FS60 series built in overvoltage protection circuit. When the OVP trigger, the output will be shut down. The input must be taken out(for at least five seconds), and than re-inputted manually. Otherwise, the module will not operate.

Soldering Information

The product is intended for through hole mounting in a PCB, When wave soldering is used, the temperature on the pins is specified to maximum 260°C for maximum 10 seconds when hand soldering, care should be taken to avoid direct contact between the hot soldering iron tip and the pins for more than a few seconds in order to prevent overheating.

EMI Characteristic (conducted Emission)

In order to reduce conducted noise install an external input filter as shown in below.

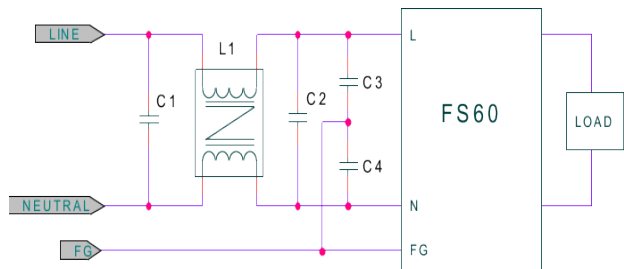

Model Number	L1	C1	C2	C3,C4
FS60-12	10mH	330nF	1uF	2200pF

Complies with CISPR 22 CLASS B

**FS60 Series – Isolated AC/DC Converters**
85 - 264Vac Input, Maximum Power: 60WData Sheet
June 1, 2011**Pin assignments**

TOP VIEW

**Single Output**

PIN NO	NAME	FUNCTION
1	FG	Frame Ground
2	AC(L)	AC Input
3	AC(N)	AC Input
4	+Vout	Positive side of output voltage
5	-Vout	Negative side of output voltage
6	No pin	

Dual Output

PIN NO	NAME	FUNCTION
1	FG	Frame Ground
2	AC(L)	AC Input
3	AC(N)	AC Input
4	-Vout	Negative side of output voltage
5	COM	Ground of output voltage
6	+Vout	Positive side of output voltage



FS60 Series – Isolated AC/DC Converters
85 - 264Vac Input, Maximum Power: 60W

Data Sheet
June 1, 2011

Mechanical Specification

TOP VIEW

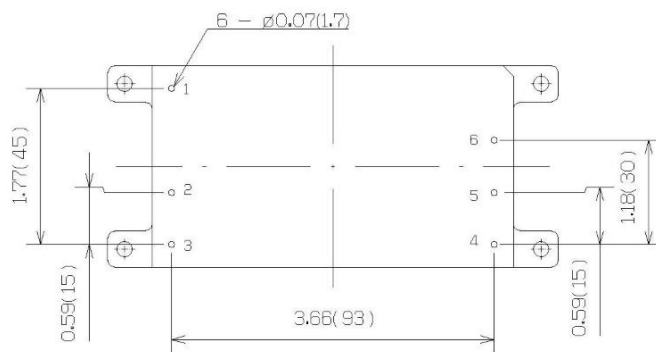
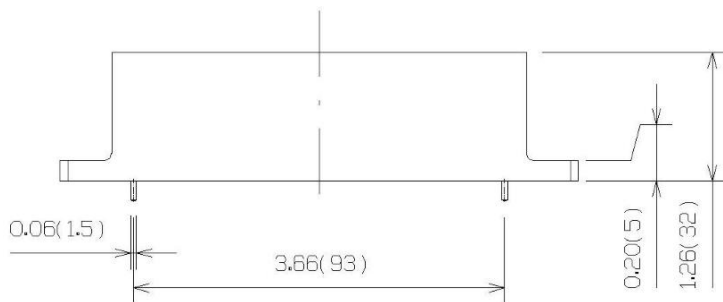
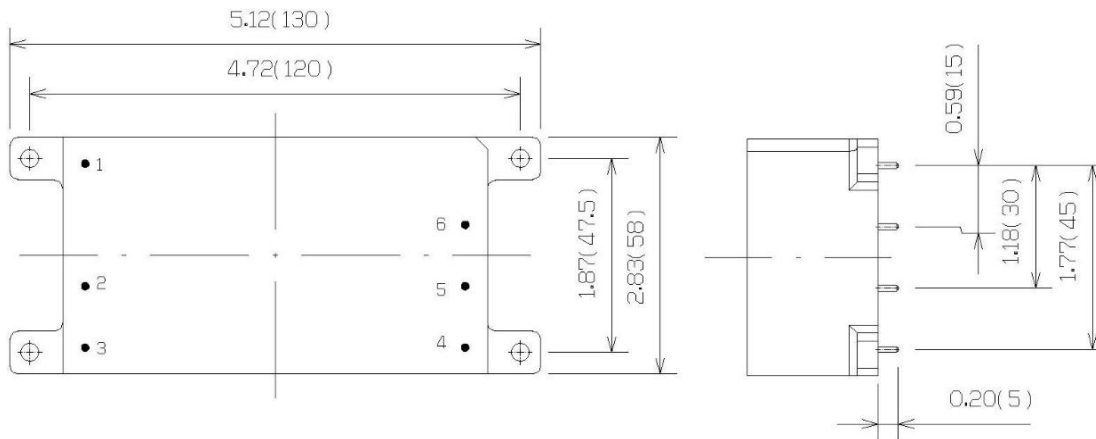

※ Mounting hole top view

**FS60 Series – Isolated AC/DC Converters**
85 - 264Vac Input, Maximum Power: 60WData Sheet
June 1, 2011

All dimensions are inches and (mm)

Ordering Information

Input	Output1, Output2	Maximum Power	Ripple & Noise Typ.	Efficiency Typ.	Model Number
85 - 264V	5V@10A	50W	80mVp-p	83%	FS60-5(C)
	12V@5A	60W	120mVp-p	87%	FS60-12(C)
	15V@4A	60W	150mVp-p	88%	FS60-15(C)
	+12V@2.5A, -12V@2.5A	60W	120mVp-p	87%	FSD60-1212(C)
	+15V@2A, -15V@2A	60W	150mVp-p	88%	FSD60-1515(C)

* (C): Chassis mount type



FS60 Series – Isolated AC/DC Converters
85 - 264Vac Input, Maximum Power: 60W

Data Sheet
June 1, 2011

Part number structure

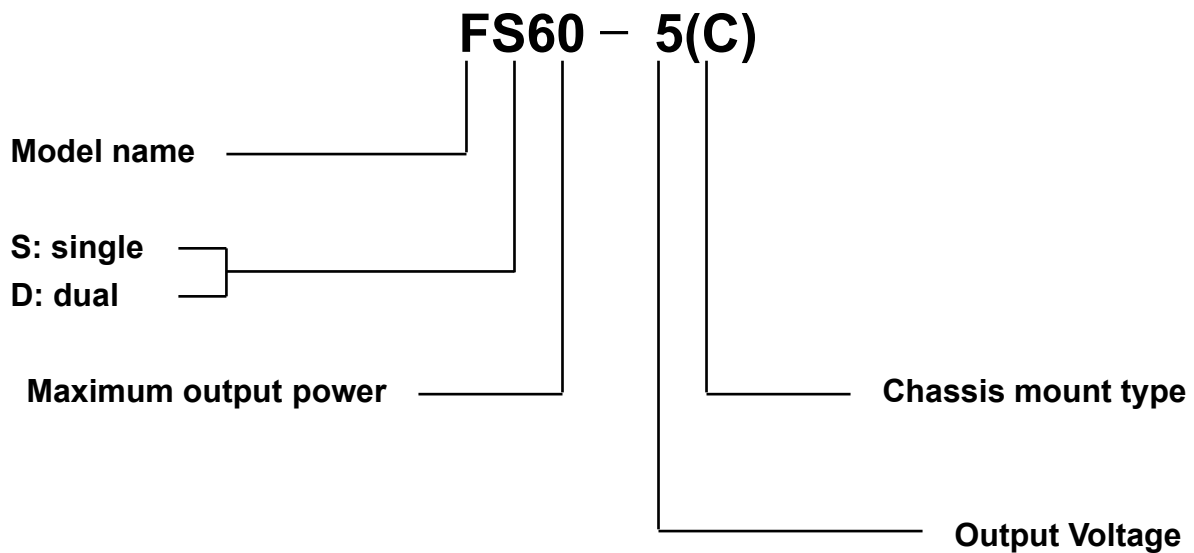

No part of this publication may be copied, transmitted, or stored in a retrieval system or reproduced in any way including, but not limited to, photography, photocopy, or Other recording means, without prior written permission from Powerplaza co.,Ltd



HEAD OFFICE & FACTORY

#1401, 14F/L 6th Daeryung TechnoTown 493-6,
Gasam-Dong, Kumchon-Gu, Seoul, 153-803,
Korea
TEL: +82 2 855 4955 | FAX: +82 2 855 4954

GENERAL SALES INQUIRIES

Please feel free to
contact : sales@powerplaza.co.kr

©2011 Powerplaza co.,Ltd. Specification subject to change without notice