

**CFS5 Series – Isolated AC/DC Converters**  
85 – 264Vac Input, Maximum Power: 5WData Sheet  
Jun 11, 2012**CFS5 Series –Low cost chassis type  
Isolated AC/DC converters****Features**

- Low profile, small size case
- Non-potting type
- High Efficiency
- 100KHz fixed switching frequency
- Low power consumption at no load  
(0.3W @220VAC)
- Universal input range
- Over current protection
- Over voltage protection (Latch)
- Output short circuit protection
- Input – Output Isolated
- Safety agency approval : Pending  
UL (UL 60950,CSA C22.2 NO.60950)  
CE (EN 60950) through TÜV
- RoHS directive

**Applications**

- Telecommunication
- Datacom
- Instrumentation
- Distributed Power System

**Description**

CFS5 Series is a low cost high efficiency chassis mounting type AC/DC converter that provides up to 5 watts of output power in ultra compact size. This module specialized in chassis mounting and an input /output connection is a terminal block type. Because this module is a non potting type converter it has a very light weight. This module has a low power consumption at no load condition(0.3W). A limited EMI filter is included and an additional EMI filter to input side is required to meet CISPR22-B

**CFS5 Series – Isolated AC/DC Converters**  
**85 – 264Vac Input, Maximum Power: 5W**Data Sheet  
Jun 11, 2012

EMI standard.

## Absolute Maximum Ratings

Parameter	Min	Typ	Max	Unit	Notes
Input Voltage Continuous	85	-	264	VAC	
Operating Ambient Temperature	-10	-	50	°C	
Storage Temperature	-20	-	70	°C	
I/O Isolation Voltage	-	-	3000	VAC	

Stresses in excess of the absolute maximum ratings can cause permanent damage to the device

## Electrical Specifications

### Input Characteristics

T<sub>A</sub> = +25°C, V<sub>in</sub> = 85 ~ 264VAC After warm up unless otherwise specified

Parameter	Symbol	Min	Typ	Max	Unit
Operating voltage Range		85		264	Vac
No load Input Power					W
CFS5-3R3			0.3		
CFS5-5			0.3		
CFS5-12			0.3		
CFS5-15			0.3		
CFS5-24			0.3		
CFS5-1212			0.3		
CFS5-1515			0.3		
Inrush Current@Cold start				20A max 40A max	@110VAC @220VAC
Operating Frequency		44		140	Hz

### Output Characteristics

T<sub>A</sub> = +25°C, V<sub>in</sub> = 85 ~ 264VAC After warm up unless otherwise specified

**CFS5 Series – Isolated AC/DC Converters**  
**85 – 264Vac Input, Maximum Power: 5W**
Data Sheet  
Jun 11, 2012

Parameter	Symbol	Min	Typ	Max	Unit
Output Voltage tolerance	V <sub>o</sub>	-	-	±2	%
Output Current	I <sub>o</sub>				
CFS5-3R3				1.25	A
CFS5-5				1	A
CFS5-12				0.42	A
CFS5-15				0.33	A
CFS5-24				0.21	A
Output Regulation;					
- Line Regulation (From minimum input voltage to maximum input voltage, constant load)		-	-	±1	%
- Load Regulation (From no load to maximum load, Constant load)		-	-	±1(Single) ±2(Dual)	%
Output Current Limit (Automatic recovery)		>105			%
Output Ripple and noise (V <sub>in</sub> =220Vac I <sub>o</sub> =Max Output Current Bandwidth 20MHz, 1uF Ceramic cap)	mVp-p	-	1% of V <sub>out</sub>		mV
Efficiency					
CFS5-3R3			70		%
CFS5-5			75		%
CFS5-12			79		%
CFS5-15			79		%
CFS5-24			81		%
(100% of max I <sub>o</sub> , V <sub>in</sub> = 220VAC)					%
Dynamic Load Response (1uF Ceramic 25% to 50 %, 50% to 25%, Slew rate = 0.05A/us)			±	3% of Output Voltage	mV

**CFS5 Series – Isolated AC/DC Converters**  
**85 – 264Vac Input, Maximum Power: 5W**
Data Sheet  
Jun 11, 2012

Start – Up Time		-	-	20	ms
Hold – Up Time		50			ms
Turn – on overshoot		-	-	1	%
Maximum output capacitance					$\mu\text{F}$

### Isolation Specifications

Parameter	Symbol	Min	Typ	Max	Unit
I/O Isolation Voltage (AC500V, 1 Min)					
- Input-Output:			-	3000	VAC
- Input-Case:			-		VAC
- Output-case:			-		VAC
Isolation Resistance - Output-Case (at DC500V at 25°C And 70%RH for 1 min)	RISO	>100	-	-	M $\Omega$
Isolation Capacitance	CISO				pF

### General Specifications

Parameter	Symbol	Min	Typ	Max	Unit
Switching Frequency			100		KHz
MTBF (MiL-HDBK- 217F)		4.5 x 10 <sup>5</sup>			hrs
Dimensions (W.H.L)		17.8 x 33.5 x 73.8			mm
Weight					Grams

### Environmental

Parameter	Symbol	Min	Typ	Max	Unit
Operating Temperature		-10		50	°C
Operating Humidity (RH non-condensing)		5		95	%



---

**CFS5 Series – Isolated AC/DC Converters**  
**85 – 264Vac Input, Maximum Power: 5W**Data Sheet  
Jun 11, 2012

Storage Temperature		-20		70	°C
Vibration @10G(98m/s <sup>2</sup> )		10		55	Hz

**Characteristic Curves**  
**Efficiency Curves**



### CFS5 Series – Isolated AC/DC Converters 85 – 264Vac Input, Maximum Power: 5W

Data Sheet  
Jun 11, 2012

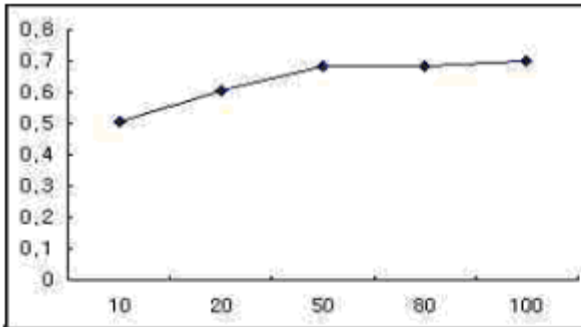

Load(%)	10	20	50	80	100
Eff(%)	50.8%	60.6%	68.2%	68.6%	70.0%

CFS5 – 3R3

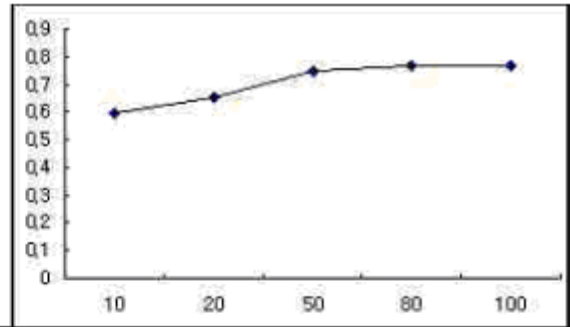

Load(%)	10	20	50	80	100
Eff(%)	59.5%	65.0%	74.6%	76.5%	76.8%

CFS5 – 5

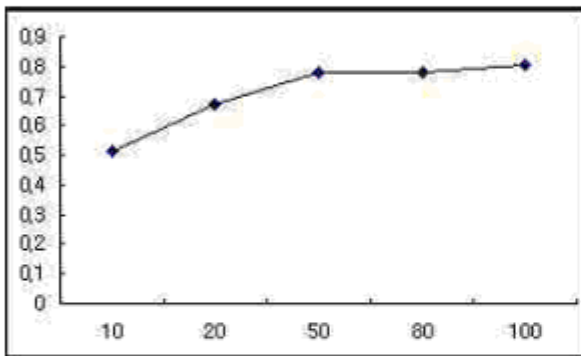

Load(%)	10	20	50	80	100
Eff(%)	51.4%	66.9%	77.7%	77.8%	80.2%

CFS5 – 12

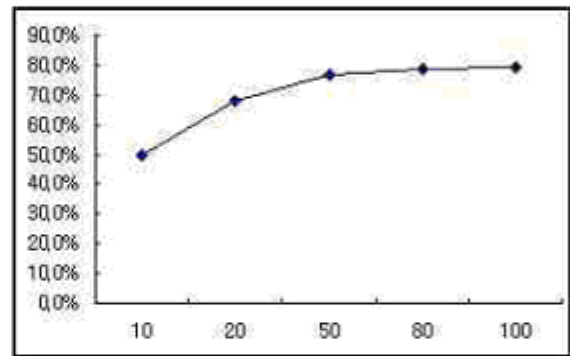

Load(%)	10	20	50	80	100
Eff(%)	50.0%	68.1%	76.5%	78.7%	79.5%

CFS5 – 15

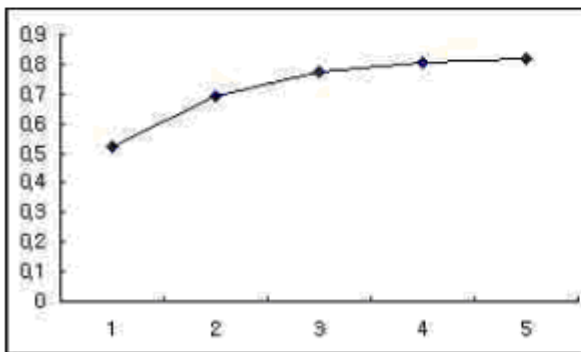

Load(%)	10	20	50	80	100
Eff(%)	52.1%	69.0%	77.5%	80.5%	81.6%

CFS5 – 24

Input 220Vac, Variation of efficiency,  
from minimum load to maximum load.

### Output Ripple & Noise



# CFS5 Series – Isolated AC/DC Converters

85 – 264Vac Input, Maximum Power: 5W

Data Sheet  
Jun 11, 2012

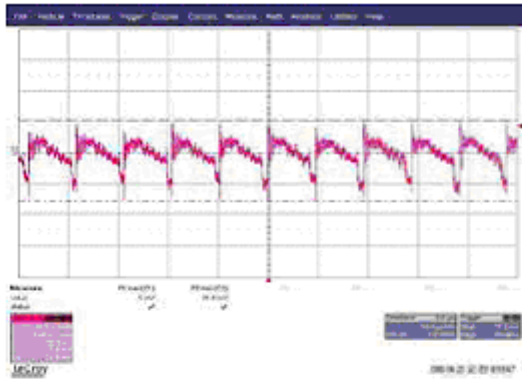

CFS5 – 3R3 51.6mVpp

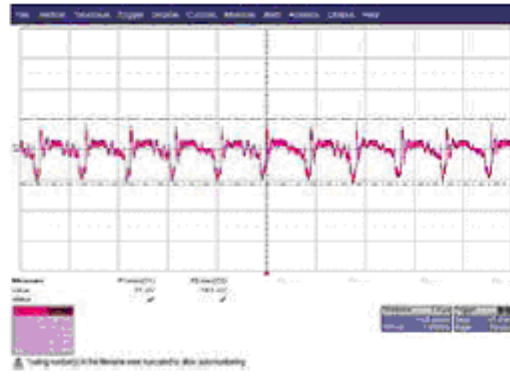

CFS5 – 5 41.2mVpp

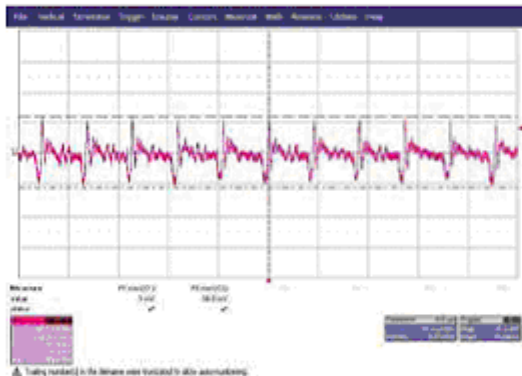

CFS5 – 12 46.2mVpp



CFS5 – 15 40.2mVpp



CFS5 – 24 74.6mVpp

\*Ripple & Noise: Oscilloscope bandwidth 20MHz.  
The length of the output line should be shorter than 1meter and it needs to be twisted.

## Start-up Time



# CFS5 Series – Isolated AC/DC Converters

85 – 264Vac Input, Maximum Power: 5W

Data Sheet  
Jun 11, 2012

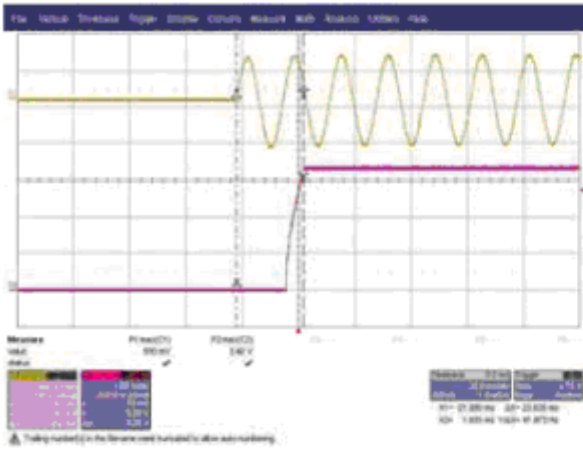

CFS5 – 3R3 23.8ms

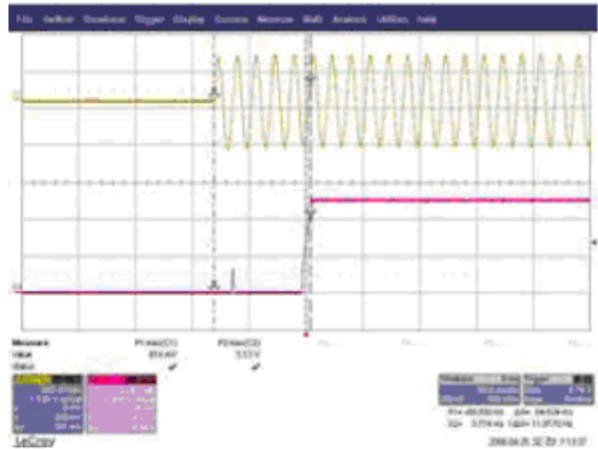

CFS5 – 5 84.6ms

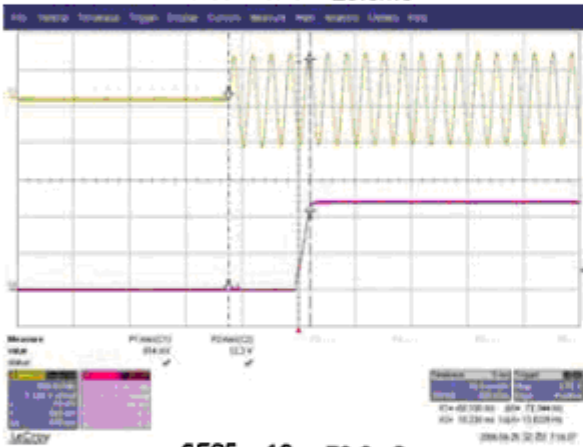

CFS5 – 12 72.3ms

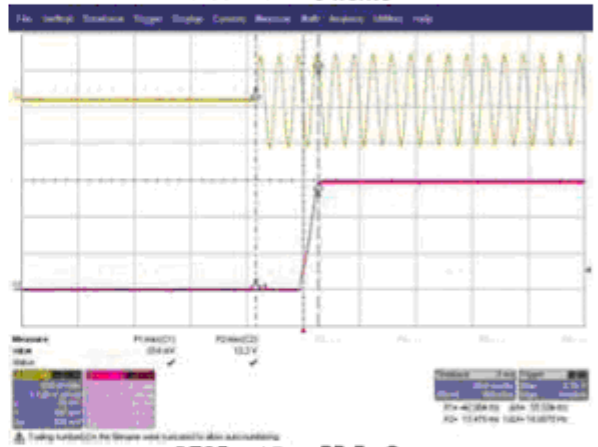

CFS5 – 15 55.5ms

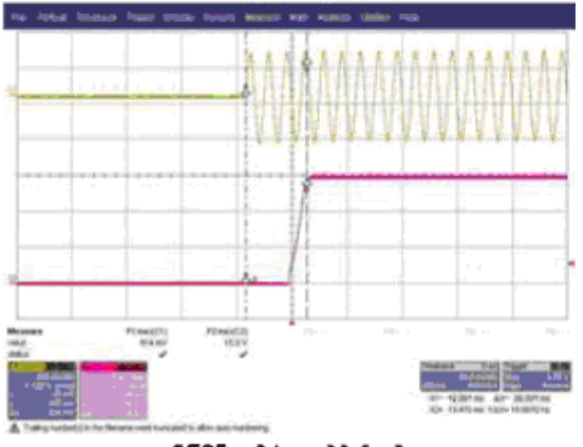

CFS5 – 24 32.9ms

Amount of delay time and rise time. After input-voltage injects.

## Hold Up Time





# CFS5 Series – Isolated AC/DC Converters 85 – 264Vac Input, Maximum Power: 5W

Data Sheet  
Jun 11, 2012

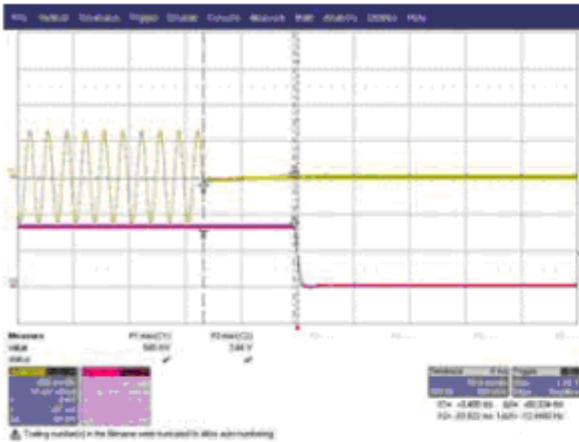

CFS5 – 3R3 80mS

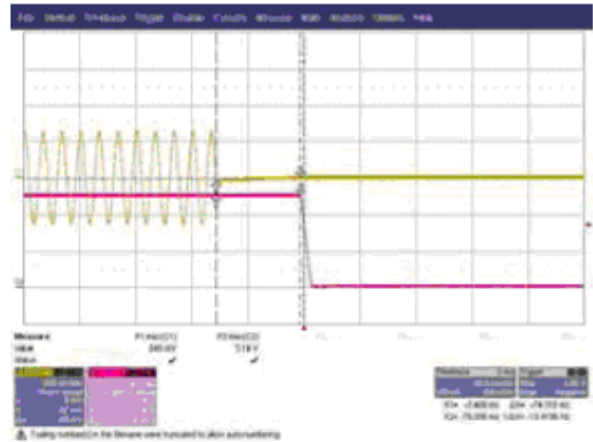

CFS5 – 5 75mS

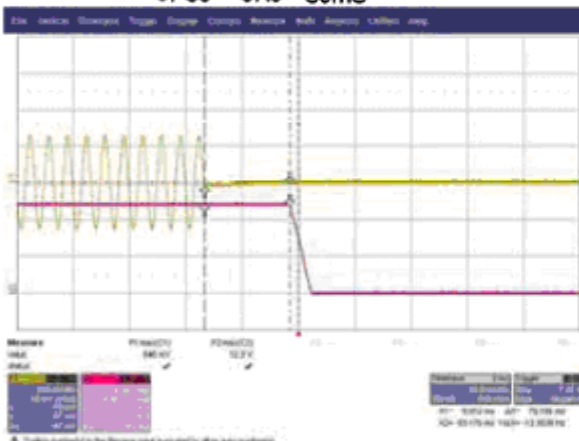

CFS5 – 12 75mS

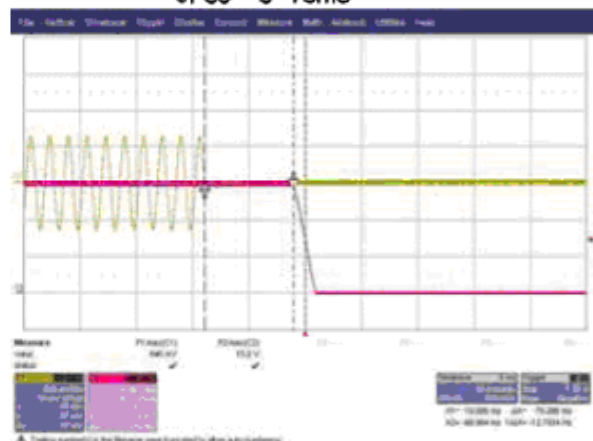

CFS5 – 15 78mS

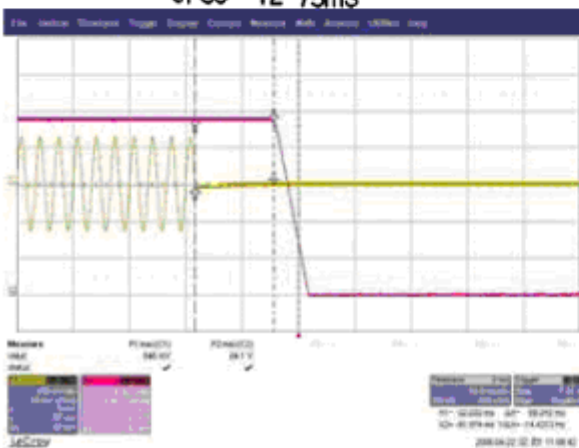

CFS5 – 24 69mS

The amount of time that a power supply's output-voltage remains within the specified-voltage ranges after it's input voltage interrupts.

- Low rating voltage
- Min10ms @100Vac

## Output Load Transient Response



### CFS5 Series – Isolated AC/DC Converters 85 – 264Vac Input, Maximum Power: 5W

Data Sheet  
Jun 11, 2012

(Dynamic load change from 0% to 100% of full load, slew rate = 0.1A/us)

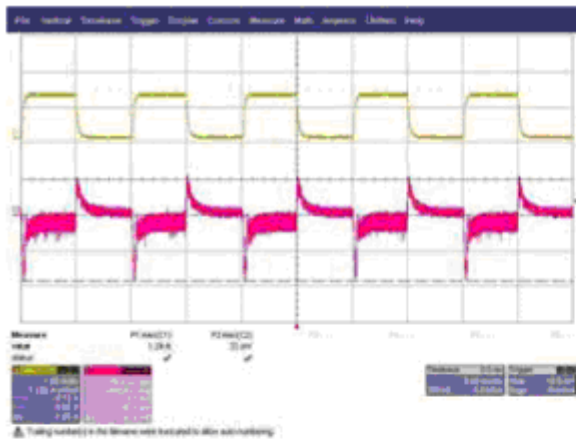

CFS5 – 3R3 92.5mV

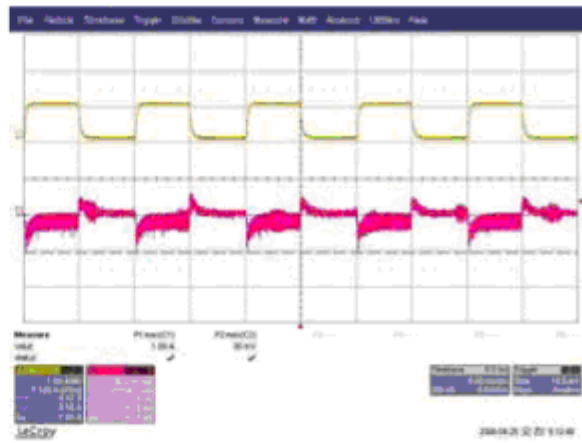

CFS5 – 5 53mV

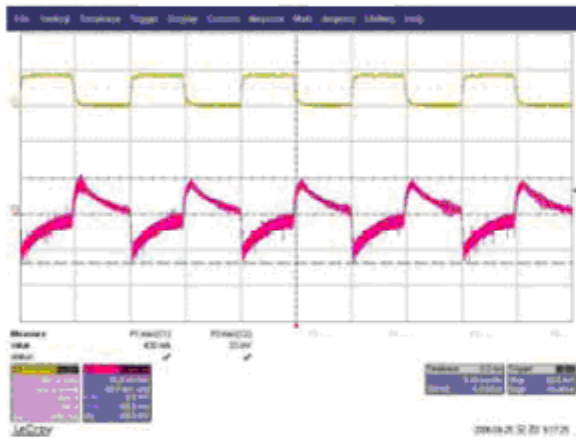

CFS5 – 12 69mV

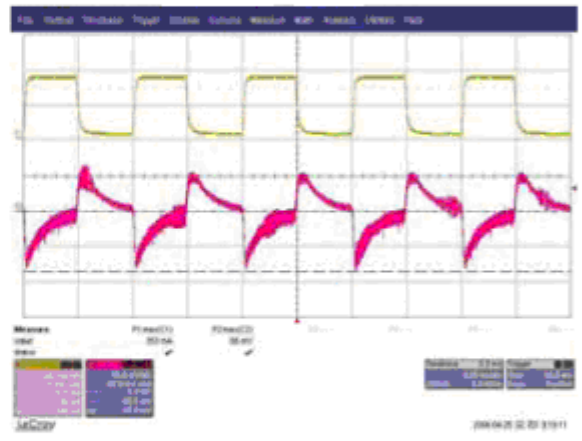

CFS5 – 15 85mV

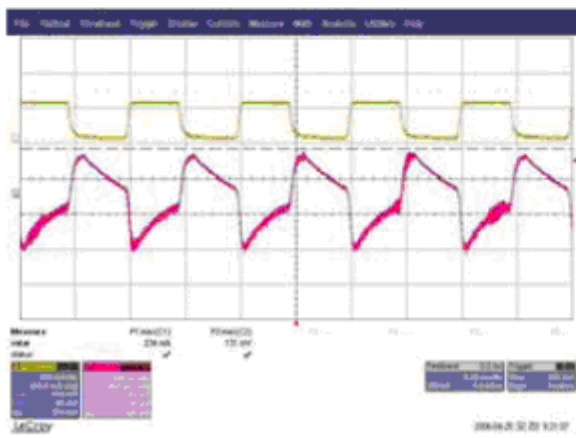

CFS5 – 24 135mV

Considerate slew rate and frequency within  $\pm 3\%$  output voltage value.

## CFS5 Series – Isolated AC/DC Converters

85 – 264Vac Input, Maximum Power: 5W

Data Sheet  
Jun 11, 2012

### Instruction manual

#### Basic connection

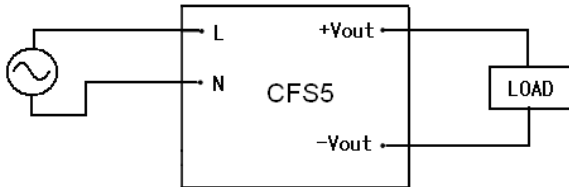

#### Output ripple and noise Test

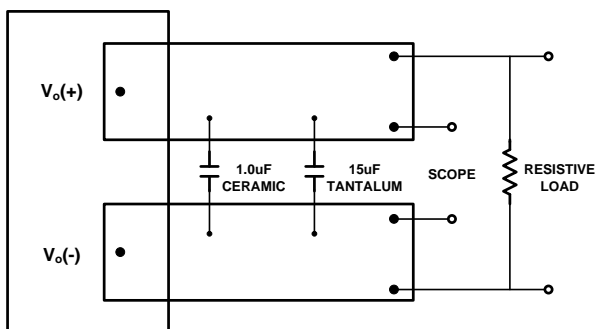

\* Conductor from Vout-pins to capacitors = 50mm (1.97in)

#### Parallel operation

Parallel operation is available by connecting the units as shown below.

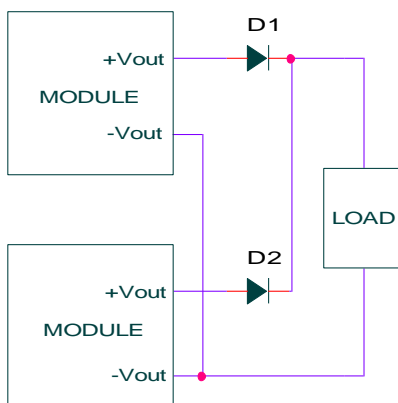

#### Series operation

Series operation is available by connecting the

outputs of two or more power supplies, as shown below. Output current in series connection should be lower than the lowest current in each unit. (Please use schottky barrier diode)

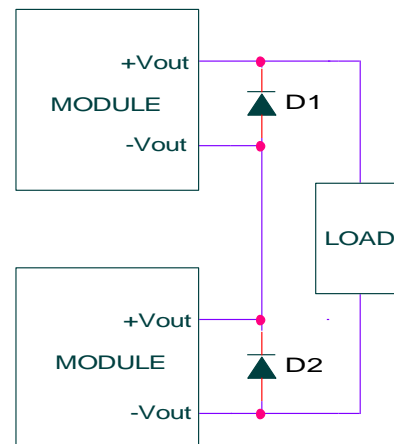

#### Thermal Considerations

CFS5 series has wide operating temperature range from  $-10^{\circ}\text{C}$  to  $+60^{\circ}\text{C}$ .

However, it should be required a enough air flow for more reliable operation. Output derating curve provide designers with a quantity of a current under the desired ambient temperature and velocity of a airflow.

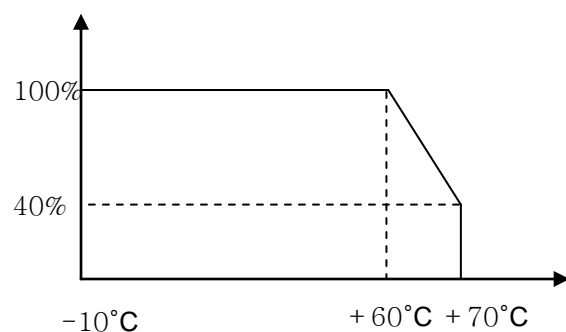

#### Feature Description

## CFS5 Series – Isolated AC/DC Converters 85 – 264Vac Input, Maximum Power: 5W

Data Sheet  
Jun 11, 2012

### Input Fuse

In order to comply with safety requirements, CFS5 series has a fuse built in. (Fusible resistor)

### Input Output Filter

CFS5 series have an internal EMI filter. To reduce conducted noise, additional external input filter is required

To reduce a output ripple and noise, external capacitor is required at the output of the device

### Over current Protection (OCP)

CFS5 series built in over current protection circuit which operates when the output current is over 105% of rating and automatically recovers when over current condition is removed

If the short or overload condition continues, the power module could be damaged.

### Over Voltage Protection (OVP)

CFS5 series built in overvoltage protection circuit. (Zener Clamp)

OVP operation will be work over 130%~150% of rated output voltage.

### Soldering Information

The product is intended for through hole mounting in a PCB, When wave soldering is used, the temperature on the pins is specified to maximum 260°C for maximum 10 seconds when hand soldering, care should be taken to avoid direct contact between the hot soldering iron tip and the pins for more than a few seconds in order to prevent overheating.

### EMI Characteristic (conducted Emission)

In order to reduce conducted noise install an external input filter as shown in below.

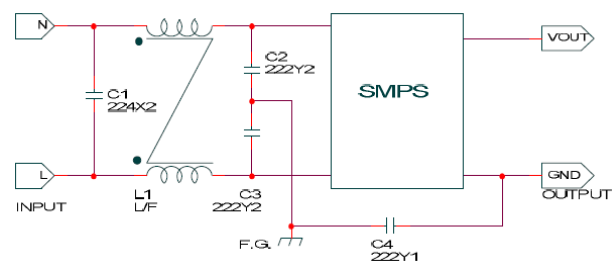

L1 = 10~30mH Common Mode Line Filter

C1 = 220nF X2 Capacitor

C2,C3 = 2200pF Y2 Capacitor

C4 = 2200pF Y1 Capacitor

**CFS5 Series – Isolated AC/DC Converters**  
85 – 264Vac Input, Maximum Power: 5WData Sheet  
Jun 11, 2012**Pin assignments**

TOP VIEW

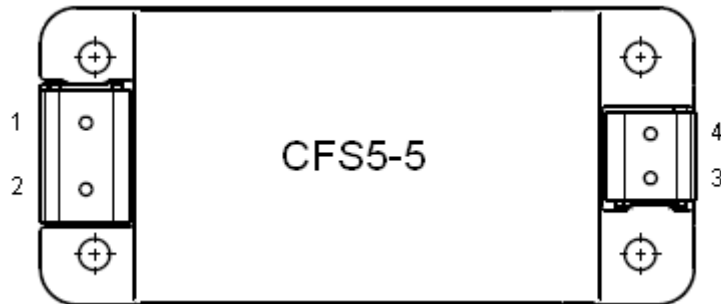
**Single Output**

PIN NO	NAME	FUNCTION
1	AC(L)	AC Input
2	AC(N)	AC Input
3	-Vout	Negative side of output voltage
4	+Vout	Positive side of output voltage

**Dual Output**

PIN NO	NAME	FUNCTION

**Mechanical Specification**



**CFS5 Series – Isolated AC/DC Converters**  
85 – 264Vac Input, Maximum Power: 5W

Data Sheet  
Jun 11, 2012

TOP VIEW

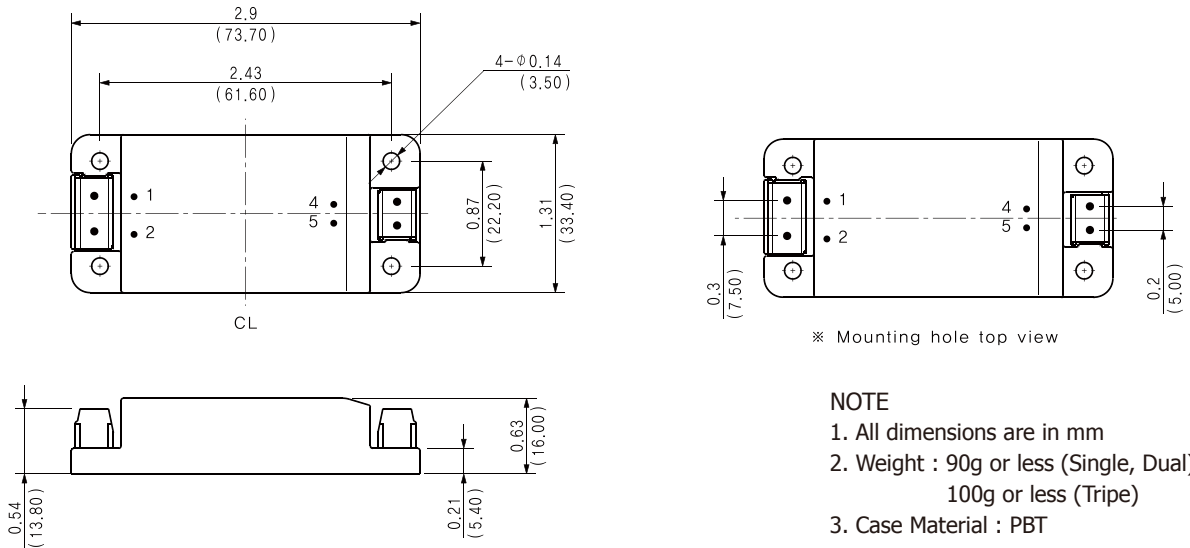

**Ordering Information**

Input	Output1, Output2	Maximum Power	Ripple & Noise Typ.	Efficiency Typ.	Model Number
85 – 264V	3.3V@1.25A	4.125W	80mVp-p	68%	CFS5-3R3
	5V@1A	5W	80mVp-p	75%	CFS5-5
	12V@0.42A	5W	120mVp-p	79%	CFS5-12
	15V@0.33A	5W	150mVp-p	79%	CFS5-15
	24V@0.21A	5W	240mVp-p	81%	CFS5-24

**Part number structure**



**CFS5 Series – Isolated AC/DC Converters**  
85 – 264Vac Input, Maximum Power: 5W

Data Sheet  
Jun 11, 2012

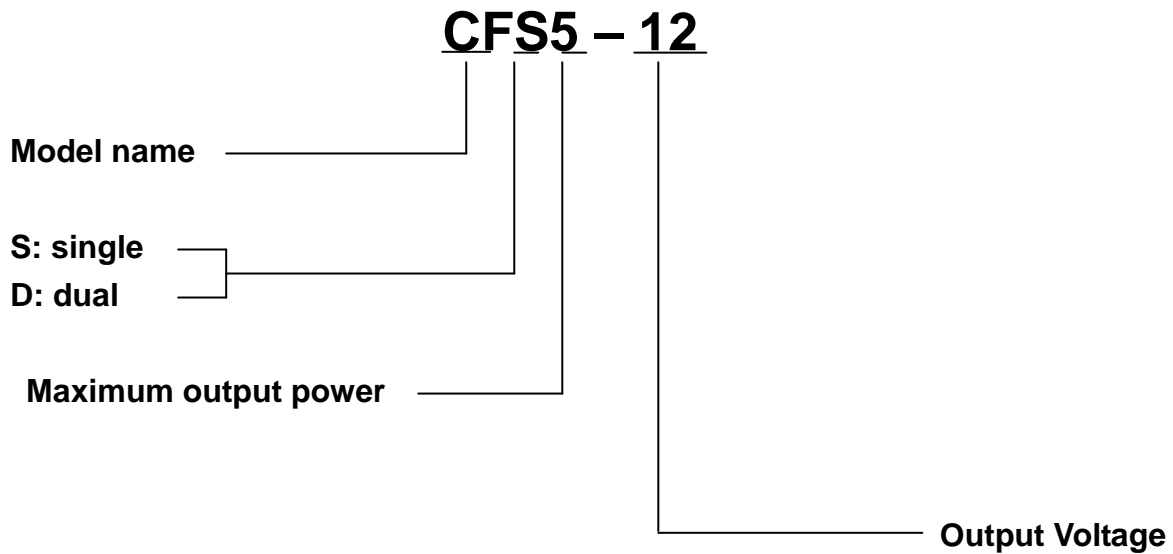

No part of this publication may be copied, transmitted, or stored in a retrieval system or reproduced in any way including, but not limited to, photography, photocopy, or Other recording means, without prior written permission from Powerplaza co.,Ltd



**HEAD OFFICE & FACTORY**

#1401, 14F/L 6th Daeryung TechnoTown 493-6,  
Gasam-Dong, Kumchon-Gu, Seoul, 153-803,  
Korea  
TEL: +82 2 855 4955 | FAX: +82 2 855 4954

**GENERAL SALES INQUIRIES**

Please feel free to  
contact : [sales@powerplaza.co.kr](mailto:sales@powerplaza.co.kr)

©2011 Powerplaza co.,Ltd. Specification subject to change without notice