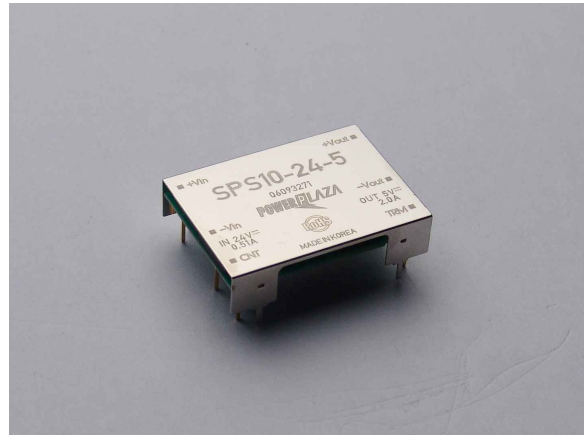

SPS10 Series – Isolated DC/DC Converters
18 – 36Vdc Input, Maximum Power: 10W**SPS10-24 Series –small size isolated DC/DC converters****Features**

- High Efficiency
- Wide operating temperature range
(-40°C to +85°C)
- Wide 2:1 input range
- Dimensions 35.60 x 8.50 x 26.0 (mm)
- Built-in over current protection circuit
- Input – Output Isolated
- Remote on/off control
- Long Life Design
- Trimmable output voltage(single output)
- Open case type
(employ only ceramic capacitor)

- **RoHS directive**

**Applications**

- Telecommunication

- Datacom

- Instrumentation/ Equipments

- Distributed Power Systems

Description

SPS Series is an isolated DC/DC converter offering designers low cost and space-efficient solution, Remote on/off, precisely regulated, over current protection.

The -40°C to 85°C operating temperature range makes the SPS series ideal for mixed analog/digital Subsystems, data communication equipments, distributed power systems. They are an excellent choice for both new design-information network system and upgrading older systems

SPS10 Series – Isolated DC/DC Converters
18 – 36Vdc Input, Maximum Power: 10W**Absolute Maximum Ratings**

Parameter	Min	Typ	Max	Unit	Notes
Input Voltage Continuous	18	-	36	Vdc	
Operating Ambient Temperature	-40	-	85	°C	
Storage Temperature	-40	-	105	°C	
I/O Isolation Voltage	-	-	500	VAC	

Stresses in excess of the absolute maximum ratings can cause permanent damage to the device

Electrical Specifications**Input Characteristics**

Parameter	Symbol	Min	Typ	Max	Unit
Operating voltage Range		18		36	Vdc
Maximum Input current (At nominal input voltage and Maximum Output Power)	I_{in}				A
No load input current					mA
SPS10-24-3R3					mA
SPS10-24-5			21		mA
SPS10-24-12			14		mA
SPS10-24-15					mA
SPD10-24-1212			28		mA
SPD10-24-1515			32		mA
Disabled input current SPS10-24-5 (Remote on/off control)					mA

SPS10 Series – Isolated DC/DC Converters

18 – 36Vdc Input, Maximum Power: 10W

Output Characteristics

T_A = +25°C, V_{in} = 18 ~ 36V unless otherwise specified

Parameter	Symbol	Min	Typ	Max	Unit
Output Voltage tolerance	V _o	-	-	±2	%
Output Current	I _o				
SPS10-24-3R3				2.0	A
SPS10-24-5				2.0	A
SPS10-24-12				0.9	A
SPS10-24-15				0.7	A
SPD10-24-1212				450	mA
SPD10-24-1515				350	mA
Output Regulation;					
- Line Regulation		-	-	±0.5	%
(From minimum input voltage to maximum input voltage, constant load)					
- Load Regulation		-	-	±1	%
(From no load to maximum load)					
Output Current Limit (Automatic recovery)		>105			%
Output Ripple and noise (V _{in} = 24V, and I _o = Max output current Bandwidth 20MHz, 1uF Ceramic cap)	mVp-p	-	-	1% of Output Voltage	mV
Efficiency					
SPS10-24-3R3			75		%
SPS10-24-5			80		%
SPS10-24-12			85		%
SPS10-24-15			85		%
SPD10-24-1212			85		%
SPD10-24-1515			85		%
(100% of max I _o , V _{in} = 24V)					

SPS10 Series – Isolated DC/DC Converters

18 – 36Vdc Input, Maximum Power: 10W

Dynamic Load Response (1uF Ceramic 50% to 100 %, 100% to 50%, Tr = 100uS)				±3% of Output Voltage	mV
Start – Up Time		-	-	10	ms
Turn – on overshoot		-	-	5	%
Maximum output capacitance					μF

Isolation Specifications

Parameter	Symbol	Min	Typ	Max	Unit
I/O Isolation Voltage (AC500V, 1 Min) - Input-Output: - Input-Case: - Output-case:			- - -	500 500 500	VAC VAC VAC
Isolation Resistance - Output-Case (at DC500V at 25°C And 70%RH for 1 min)	Riso	>100	-	-	MΩ
Isolation Capacitance	Ciso				pF

General Specifications

Parameter	Symbol	Min	Typ	Max	Unit
Switching Frequency			-		KHz
Remote ON/OFF control - Positive Logic On = short to - Vin Off = open					Vdc

SPS10 Series – Isolated DC/DC Converters
18 – 36Vdc Input, Maximum Power: 10W

Output voltage trim range			±10		%
MTBF		4.8x10 ⁵			hrs
Dimensions (W.H.L)		35.6 x 8.50 x 26.0			mm
Weight		-	10.8	-	Grams

Environmental

Parameter	Symbol	Min	Typ	Max	Unit
Operating Temperature		-40		85	°C
Operating Humidity (RH non-condensing)		5		95	%
Storage Temperature		-40		105	°C

SPS10 Series – Isolated DC/DC Converters
 18 – 36Vdc Input, Maximum Power: 10W

Characteristic Curves
Efficiency Curves

- SPS10-24-5 -

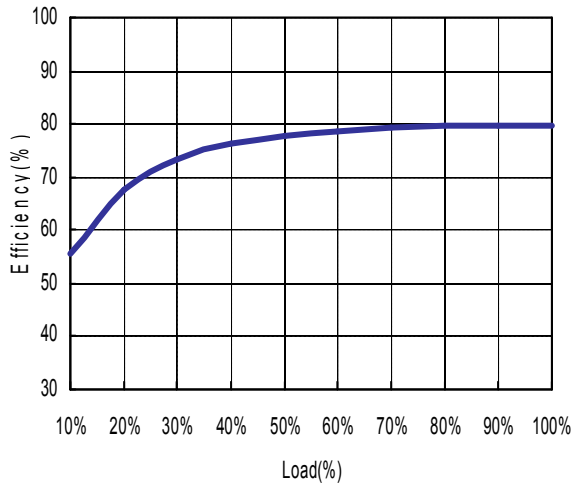

Vin=24V, Vo=5V@2.0A , At 25°C

- SPS10-24-12-

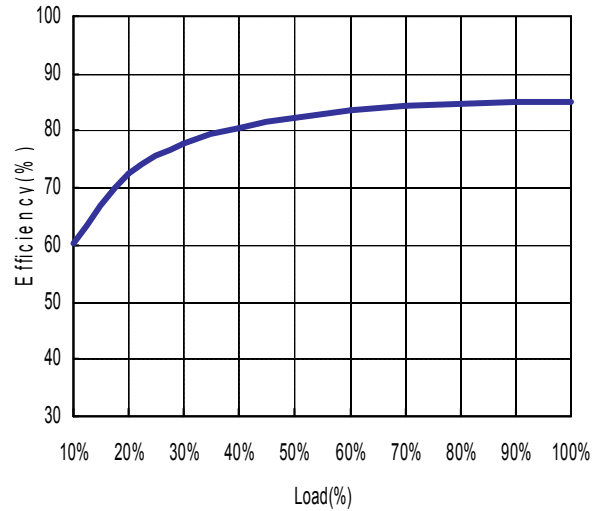

Vin=24V, Vo=12V@0.9A , At 25°C

- SPD10-24-1212 -

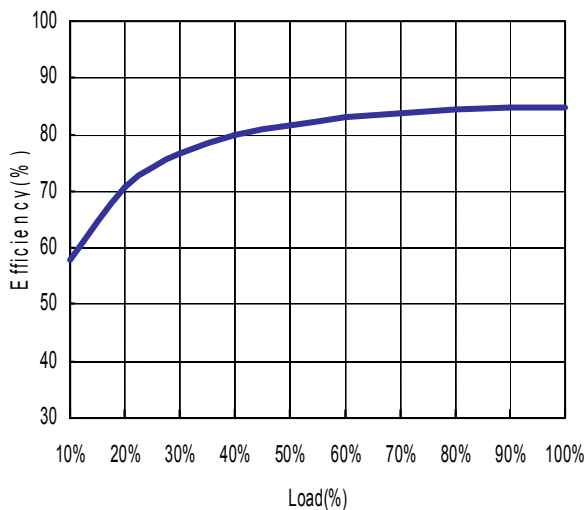

Vin=24V, Vo=+12V,-12V@0.45A , At 25°C

-SPD10-24-1515-

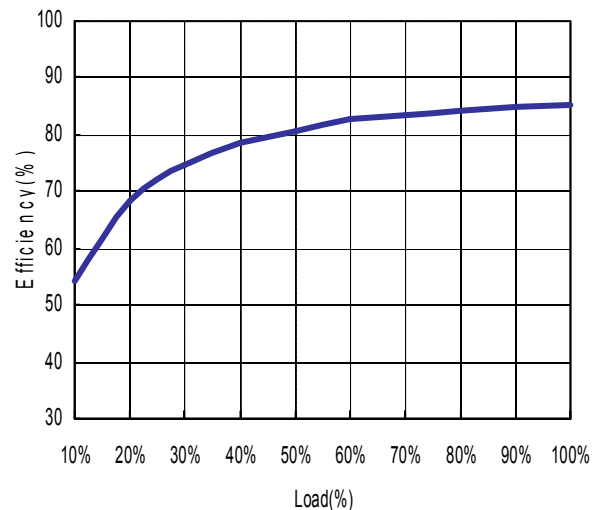

Vin=24V, Vo=+15V,-15V@0.35A , At 25°C

SPS10 Series – Isolated DC/DC Converters
18 – 36Vdc Input, Maximum Power: 10W

Input Voltage vs Input Current

- SPS10-24-5 -

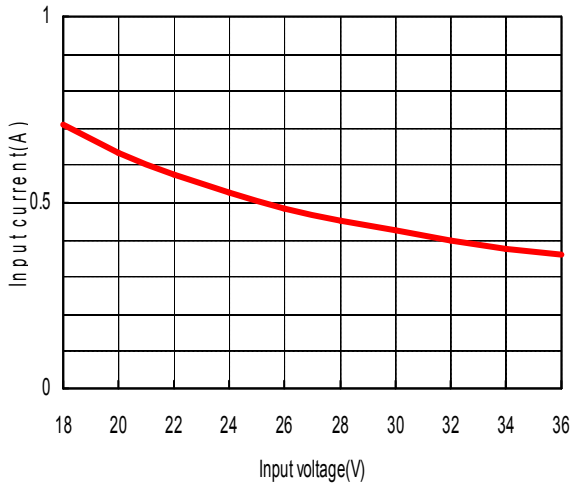

Vin=24V, Vo=5V@2.0A, At 25°C

- SPS10-24-12 -

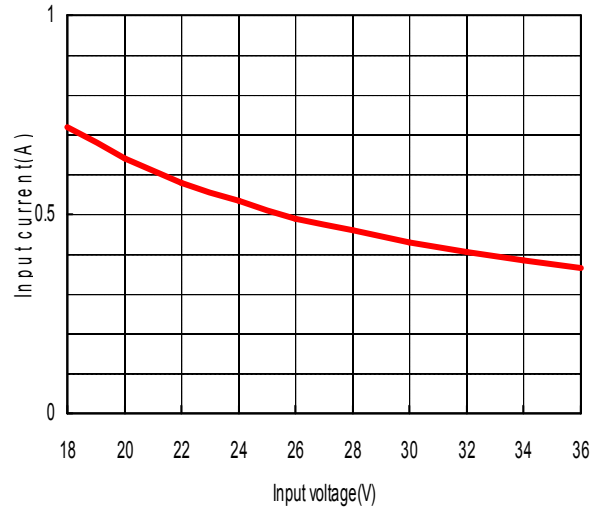

Vin=24V, Vo=12V@0.9A, At 25°C

- SPD10-24-1212 -

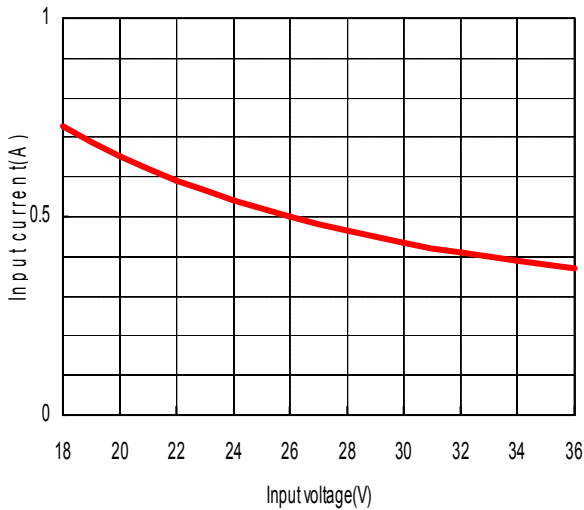

Vin=24V, Vo=+12V,-12V@0.45A, At 25°C

- SPD10-24-1515-

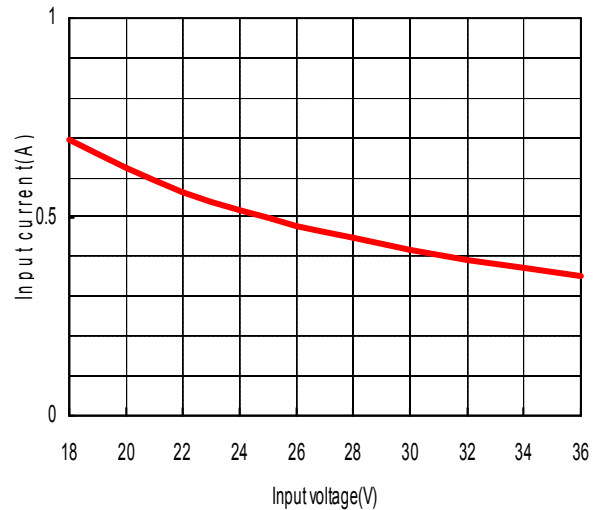

Vin=24V, Vo=+15V,-15V@0.35A, At 25°C

SPS10 Series – Isolated DC/DC Converters
 18 – 36Vdc Input, Maximum Power: 10W

Start-up from Vin

- SPS10-24-5 -

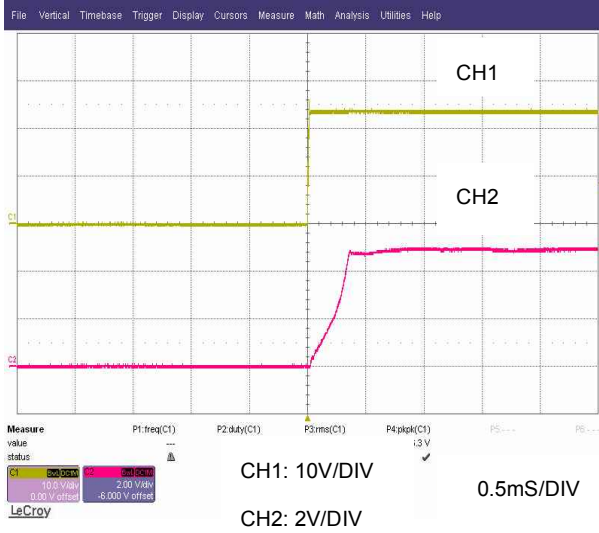

Vin=24V, Vo=5V@2.0A, At 25°C

- SPS10-24-12 -

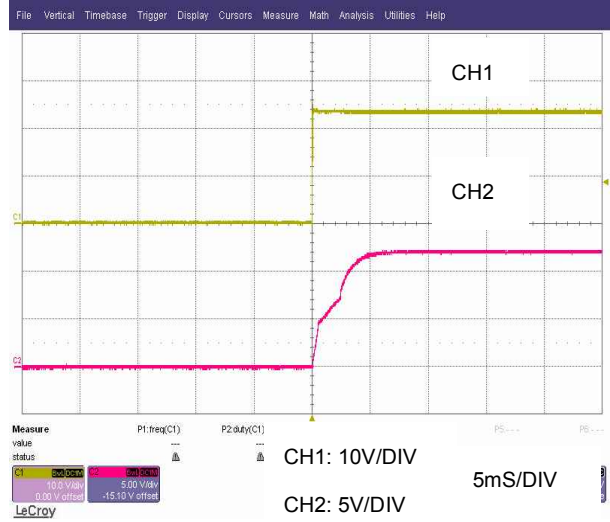

Vin=24V, Vo=12V@0.9A, At 25°C

- SPD10-24-1212 -

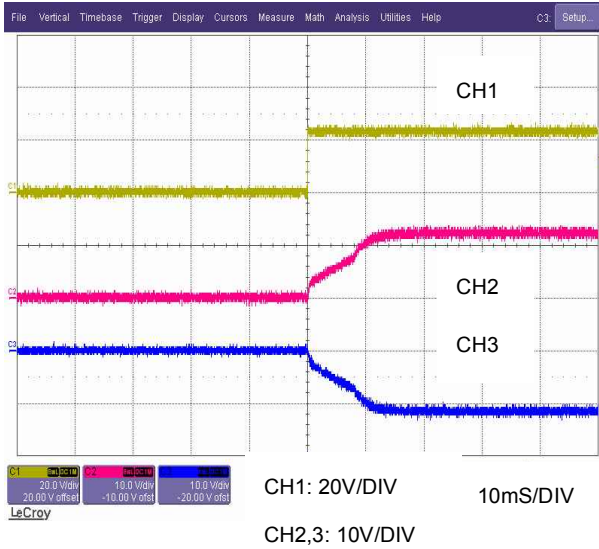

Vin = 24V, Vo=+12V,-12V@0.45A, At 25°C

- SPD10-24-1515 -

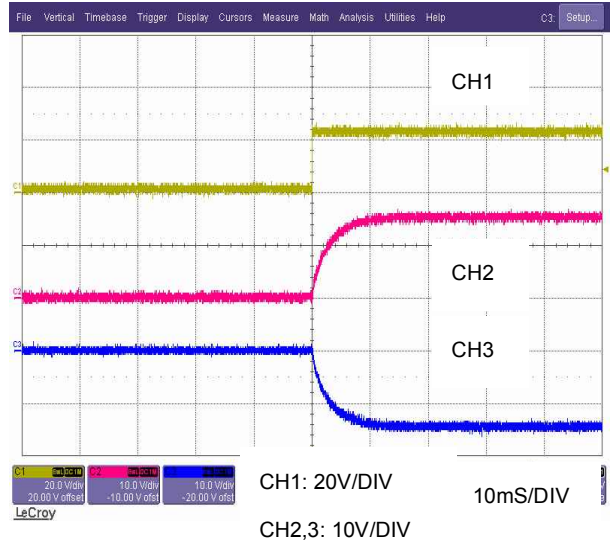

Vin = 24V, Vo=+15V,-15V@0.35A, At 25°C

SPS10 Series – Isolated DC/DC Converters
18 – 36Vdc Input, Maximum Power: 10W

Output Ripple/Noise

- SPS10-24-5 -

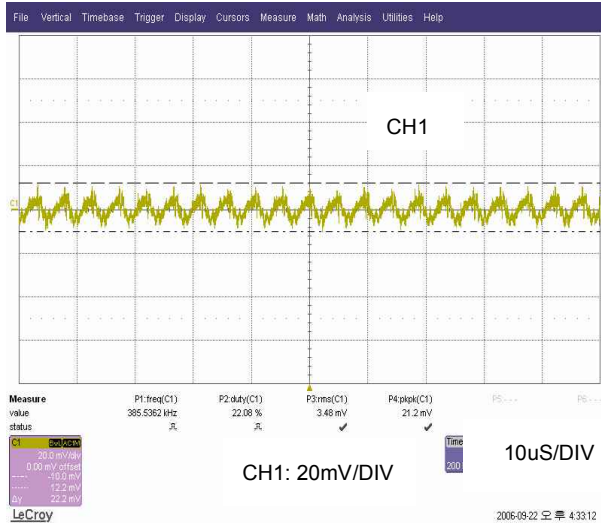

Vin=24V, Vo=5V@2.0A ,At 25°C

- SPS10-24-12 -

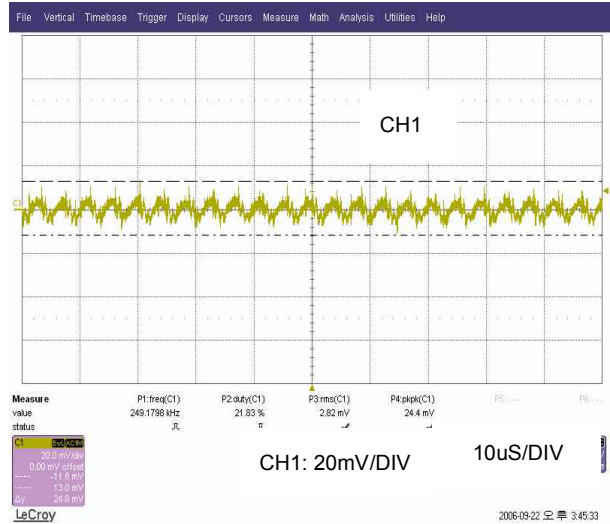

Vin=24V, Vo=12V@0.9A, At 25°C

- SPD10-24-1212 -

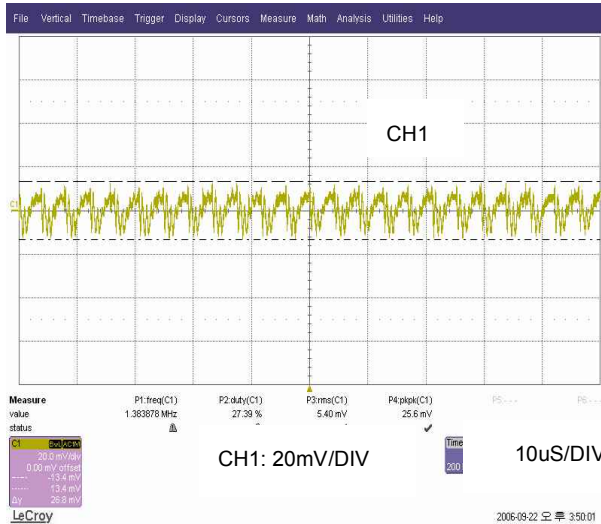

Vin = 24V, Vo=+12V,-12V@0.45A,At 25°C

- SPD10-24-1515 -

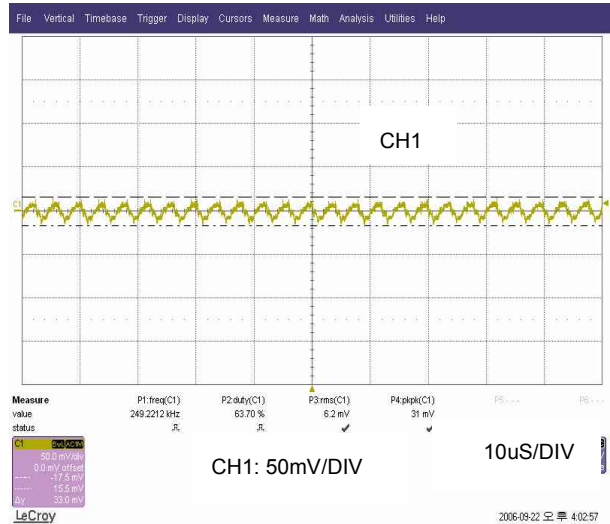

Vin = 24V, Vo=+15V,-15V@0.35A,At 25°C

SPS10 Series – Isolated DC/DC Converters
 18 – 36Vdc Input, Maximum Power: 10W

Output Load Transient Response

- SPS10-24-5 -

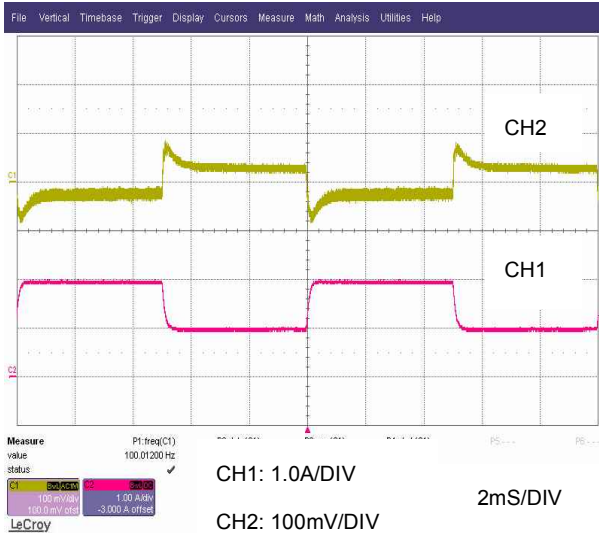

Vin=24V, Vo=5V@2.0A ,At 25°C

- SPS10-24-12 -

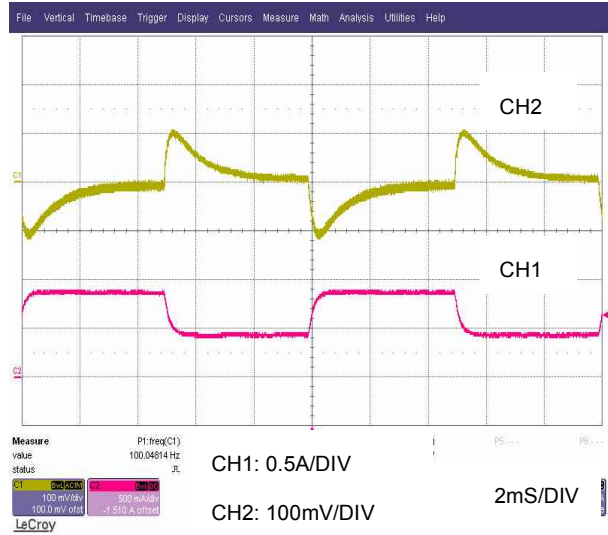

Vin=24V, Vo=12V@0.9A,At 25°C

- SPD10-24-1212 -

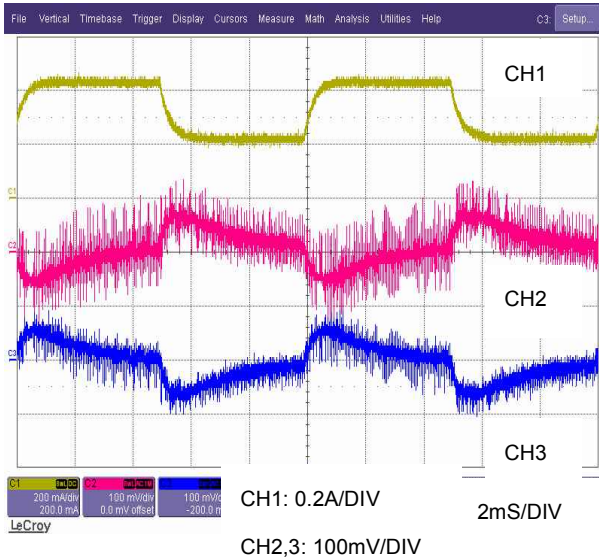

Vin = 24V, Vo=+12V,-12V@0.45A,At 25°C

- SPD10-24-1515 -

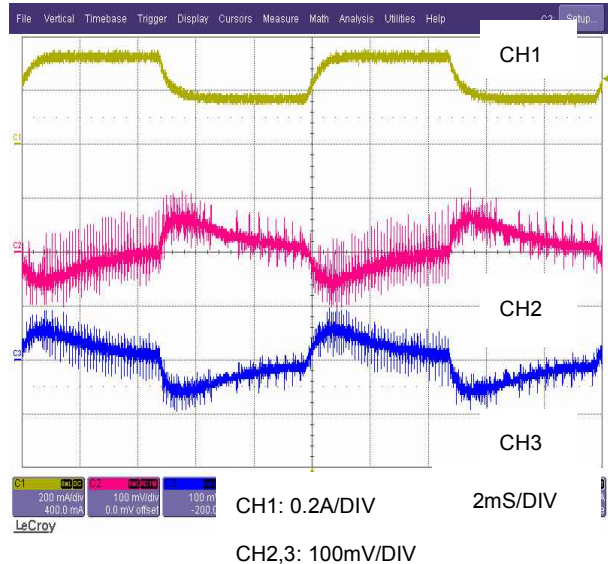

Vin=24V, Vo=+15V,-15V@0.35A,At 25°C

SPS10 Series – Isolated DC/DC Converters
 18 – 36Vdc Input, Maximum Power: 10W

TEST Configurations

Output ripple and noise Test

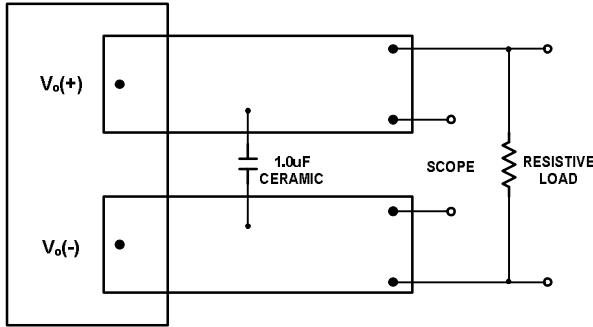

* Conductor from Vout-pins to capacitors = 50mm (1.97in)

Output Voltage and Efficiency Test

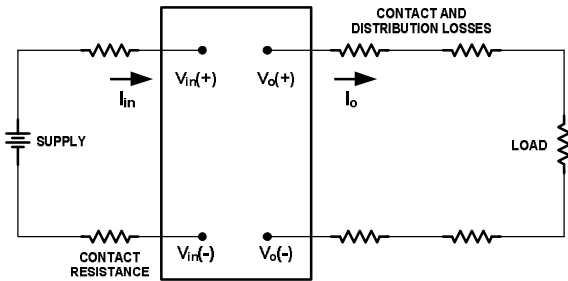

*All measurements are taken at the module terminals when Socketing, place Kelvin connections at module terminals to Avoid measurement errors due to socket contact resistance

Efficiency

$$\eta = \left(\frac{[V_o(+)-V_o(-)] \times I_o}{[V_{in}(+)-V_{in}(-)] \times I_{in}} \right) \times 100\%$$

Thermal Considerations

SPS series has wide operating temperature range from -40°C to +85°C.

However, it should be required a enough air flow for more reliable operation. Output derating curve provide designers with a quantity of a current under the desired ambient temperature and velocity of a airflow

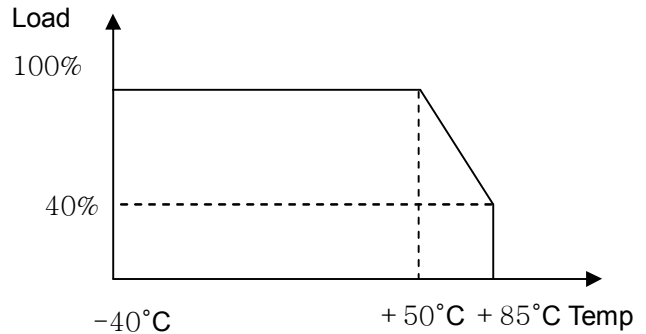

If the device is installed in a system, the device's temperature of point A should be checked if does not exceed specified temperature as below. Please make sure that the ambient temperature does not exceed 85°C.

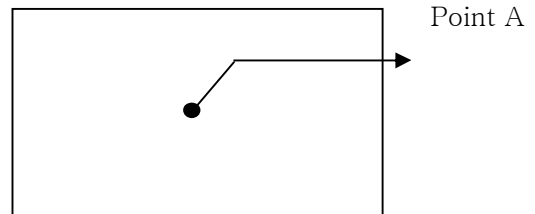

Output	1.5W	3W	6W	10W
Temp	90°C	90°C	95°C	100°C

SPS10 Series – Isolated DC/DC Converters
 18 – 36Vdc Input, Maximum Power: 10W

Feature Description

Input Fuse

In order to comply with safety requirements, SPS series has a fuse built in.

	5V	12V	24V	48V
SPS1R5	2A	1A	0.75A	0.75A
SPS3	3A	2.5A	1A	1A
SPS6	5A	2.5A	2A	1.5A
SPS10	6A	4A	2.5A	2A

Remote ON/OFF Control (CNT)

By using CNT pin you can control the output without turning the input power on or off.

If you need not this function short CNT

Pin to -Vin (Except 1.5W)

CNT Level for -Vin	OUTPUT
Open	OFF
Short	ON

Input Reverse-polarity voltage protection

Input reverse voltage protection has not built in this product.

So, you can set up a circuit externally as described below if necessary

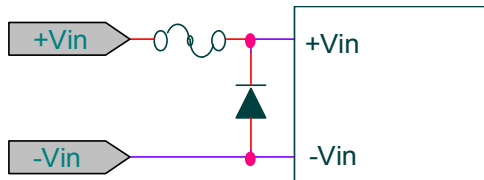

Input Output Filter

SPS series have an internal input filter. To minimize the ripple and noise of the input voltage, additional external capacitor is required (10uF ~ 680uF)

To reduce a output ripple and noise, external capacitor is required at the output of the device

Output voltage variation (Trim)

Output Voltage adjusted by using trim pin within $\pm 10\%$ of output voltage.

Use of trim function can cause the output power to increase, so you should not use beyond the SPS's specified output power rating

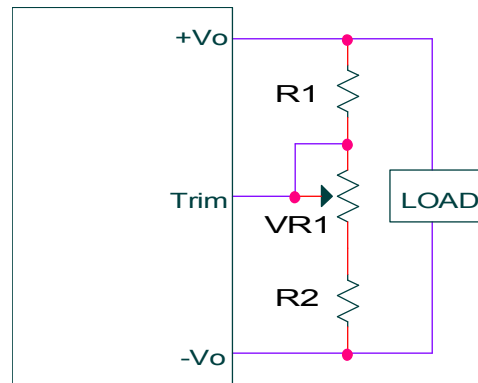

Output voltage	VR	R1	R2
3.3V	500Ω	1kΩ	560Ω
5V	1kΩ	1kΩ	680Ω
12V	1kΩ	3.9kΩ	680Ω
15V	1kΩ	5.6k	750Ω

SPS10 Series – Isolated DC/DC Converters
18 – 36Vdc Input, Maximum Power: 10W**Over current Protection(OCP)**

SPS series built in over current protection circuit
Which operates when the output current is over
105% of rating and automatically recovers when
over current condition is removed

If load is connected to a inductive or constant
current load such as lamp or motor, output may
not start up.

Over Voltage Protection(OVP)

SPS series has not built in overvoltage
protection circuit. So, you need to set up a circuit
externally which can protect the over voltage if
necessary.

Soldering Information

The product is intended for through hole
mounting in a PCB, When wave soldering is
used, the temperature on the pins is specified to
maximum 260°C for maximum 10 seconds
when hand soldering, care should be taken to
avoid direct contact between the hot soldering
iron tip and the pins for more than a few
seconds in order to prevent overheating.

SPS10 Series – Isolated DC/DC Converters
 18 – 36Vdc Input, Maximum Power: 10W

EMI Characteristic (conducted Emission)

In order to reduce conducted noise install an external input filter as shown in below.

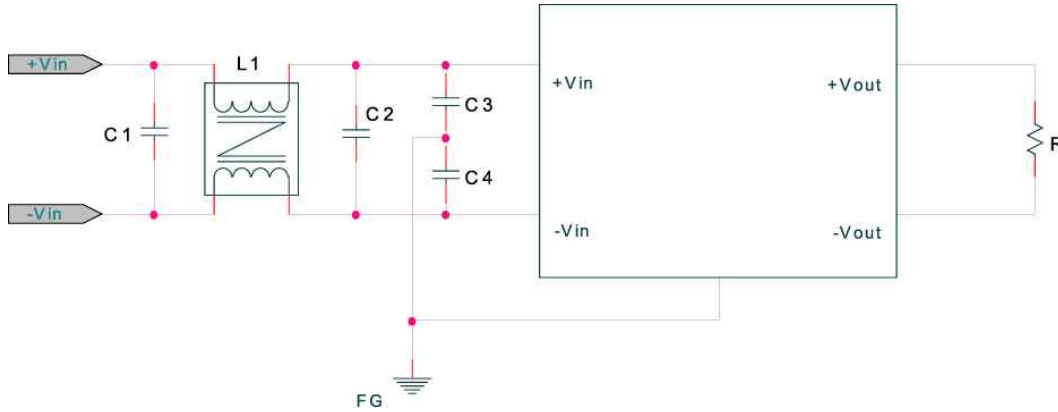

Model Number	L1	C1	C2	C3,C4
SPS10-5-5	5mH	2.2uF	220uF	2.2uF
SPS10-12-5	5mH	2.2uF	220uF	2.2uF
SPS10-24-5	11mH	2.2uF	220uF	2.2uF
SPS10-48-5	11mH	2.2uF	220uF	2.2uF

Complies with CISPR 22 CLASS B

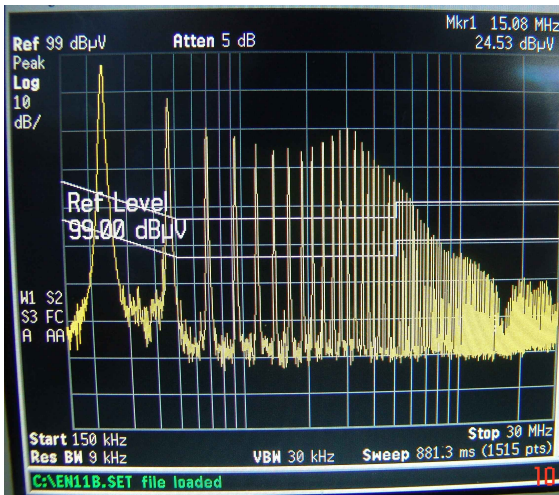

- No Filter

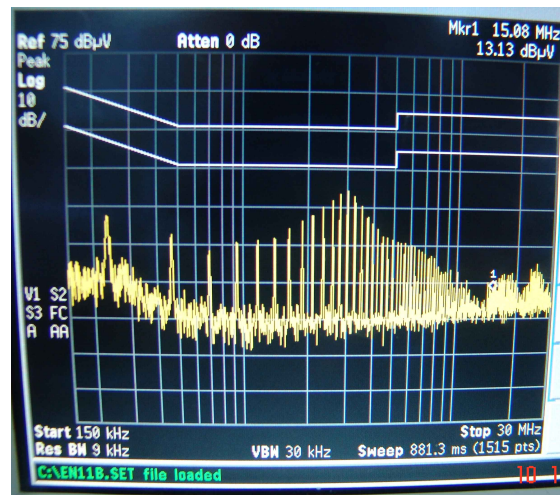

- EMI Filter : 약 50dB 감소

SPS10 Series – Isolated DC/DC Converters
 18 – 36Vdc Input, Maximum Power: 10W

Pin assignments

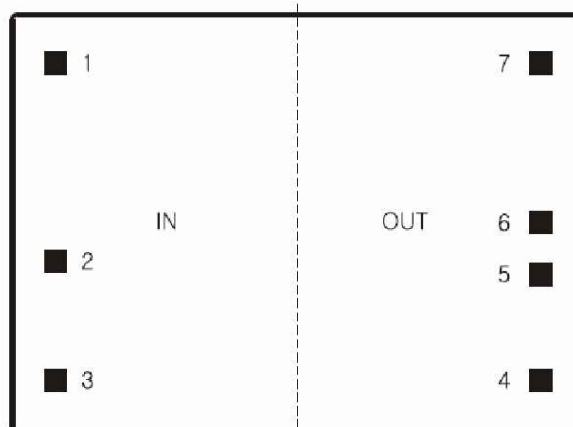

Single output

PIN NO	NAME	FUNCTION
1	+Vin	Positive terminal for 24V
2	-Vin	Negative terminal for 24V
3	CNT	Logic signal reference to Vin to Turn the converter ON/OFF
4	Trim	Output voltage variation
5	-Vout	Negative terminal for Vout
6	No pin	-
7	+Vout	Positive terminal for Vout

Dual output

PIN NO	NAME	FUNCTION
1	+Vin	Positive terminal for 24V
2	-Vin	Negative terminal for 24V
3	CNT	Logic signal reference to Vin to Turn the converter ON/OFF
4	-Vout	Negative terminal for Vout
5	No pin	-
6	COM	
7	+Vout	Positive terminal for Vout

SPS10 Series – Isolated DC/DC Converters
 18 – 36Vdc Input, Maximum Power: 10W

Mechanical Specification

TOP VIEW

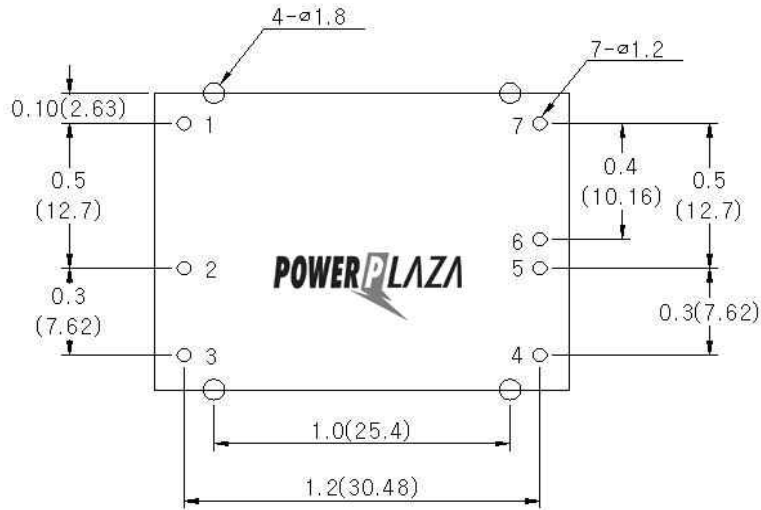

SIDE VIEW

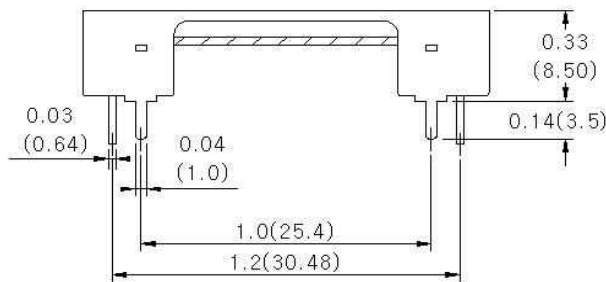

OTHER VIEW

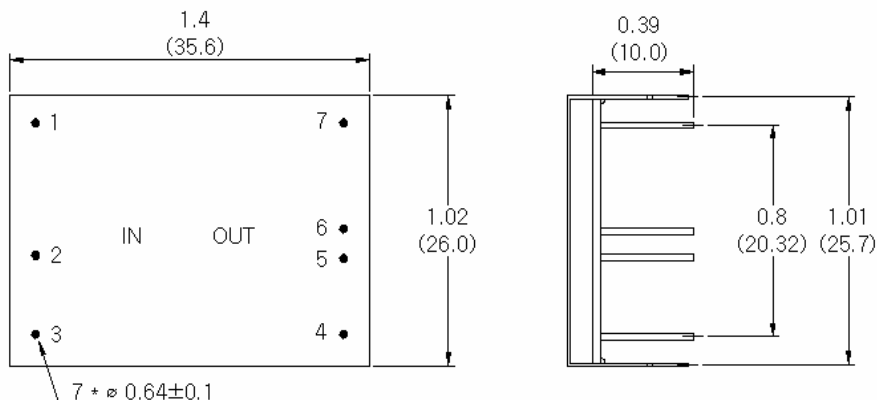

All dimensions are inches and (mm)

SPS10 Series – Isolated DC/DC Converters

18 – 36Vdc Input, Maximum Power: 10W

Ordering Information

Input	Output1, Output2	Maximum Power	Ripple & Noise Typ.	Efficiency Typ.	Model Number
4.5 - 9V	3.3V@1.6A	5.28W	50mVp-p	75%	SPS10-5-3R3
	5V@1.6A	8W	50mVp-p	78%	SPS10-5-5
	12V@0.7A	8.4W	120mVp-p	81%	SPS10-5-12
	15V@0.6A	9W	150mVp-p	83%	SPS10-5-15
	+12V@350mA, -12V@350mA	8.4W	120mVp-p	84%	SPD10-5-1212
	+15V@300mA, -15V@300mA	9W	150mVp-p	84%	SPD10-5-1515
9 – 18V	3.3V@2.0A	6.6W	50mVp-p	77%	SPS10-12-3R3
	5V@2.0A	10W	50mVp-p	81%	SPS10-12-5
	12V@0.9A	10.8W	120mVp-p	84%	SPS10-12-12
	15V@0.7A	10.5W	150mVp-p	86%	SPS10-12-15
	+12V@450mA, -12V@450mA	10.8W	120mVp-p	86%	SPD10-12-1212
	+15V@350mA, -15V@350mA	10.5W	150mVp-p	86%	SPD10-12-1515
18 – 36V	3.3V@2.0A	6.6W	50mVp-p	75%	SPS10-24-3R3
	5V@2.0A	10W	50mVp-p	80%	SPS10-24-5
	12V@0.9A	10.8W	120mVp-p	85%	SPS10-24-12
	15V@0.7A	10.5W	150mVp-p	85%	SPS10-24-15
	+12V@450mA, -12V@450mA	10.8W	120mVp-p	85%	SPD10-24-1212
	+15V@350mA, -15V@350mA	10.5W	150mVp-p	85%	SPD10-24-1515
36 – 76V	3.3V@2.0A	6.6W	50mVp-p	74%	SPS10-48-3R3
	5V@2.0A	10W	50mVp-p	80%	SPS10-48-5
	12V@0.9A	10.8W	120mVp-p	85%	SPS10-48-12
	15V@0.7A	10.5W	150mVp-p	85%	SPS10-48-15
	+12V@450mA, -12V@450mA	10.8W	120mVp-p	84%	SPD10-48-1212

SPS10 Series – Isolated DC/DC Converters
18 – 36Vdc Input, Maximum Power: 10W

	+15V@350mA, -15V@350mA	10.5W	150mVp-p	84%	SPD10-48-1515
--	---------------------------	-------	----------	-----	---------------

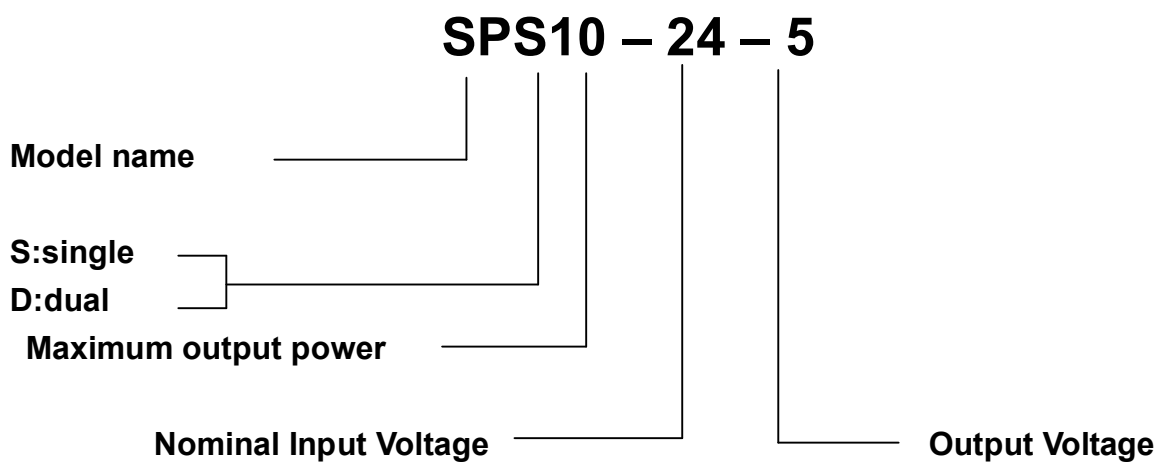
Part number structure

No part of this publication may be copied, transmitted, or stored in a retrieval system or reproduced in any way including, but not limited to, photography, photocopy, or Other recording means, without prior written permission from Powerplaza co.,Ltd

HEAD OFFICE & FACTORY

#1402, 14F/L 6th Daeryung TechnoTown 493-6,
Gasam-Dong, Kumchon-Gu, Seoul, 153-774,
Korea

TEL: +82 2 855 4955 | FAX: +82 2 855 4954

GENERAL SALES INQUIRIES

Please feel free to

contact : sales@powerplaza.co.kr

©2007 Powerplaza co.,Ltd. Specification subject to change without notice